



# Message Implementation Guide

## BulkMailOrder Message

### Business to Business (B2B) webservice

April 5th, 2022

Auteur Frank Weusten  
Tel

Rapport **Message Implementation Guide**  
BulkMailOrder Message

Versie 4.1





## Version control

Version	Date	Author	Description
2.4	27-3-2015	Jaco Oskam	Initial version based on "Handleiding B2B v2 3_ENG.pdf" with the following changes: - Additional elements for sorted products. - Errors in message structure and functional errors are reported differently.
2.9	4-5-2015	Jaco Oskam	Introduced issues. Contract data is optional. More consistency between Pre-Advice and Tender. Customer names and locations removed from response.
2.91	22-5-2015	Jaco Oskam	Updated description of master data
3.0	3-7-2015	Jaco Oskam	Error codes provided in chapter 6
3.1	21-9-2015	Jaco Oskam	Error codes and messages are not mandatory in requests ProductWeight and TotalWeight corrected DestinationZone instead of DestinationZoneID 3 additional MailingWrapperTypeCode options 1 less AddressLabelingTypeCode option
3.2	13-10-2015	Manon Havinga	<ul style="list-style-type: none"> <li>• 2 additional technical error codes</li> <li>• 2 additional functional error codes</li> <li>• Explanation XSD versus MIG added</li> <li>• Decimal separator added</li> <li>• PhysicalDataThicknessClass corrected + error code added</li> <li>• PhysicalDataQuantity corrected + error code added</li> </ul>
3.3	1-2-2016	Manon Havinga	<ul style="list-style-type: none"> <li>• 6 functional error codes added</li> <li>• 3 functional error codes adjusted</li> <li>• 1 functional error code expired</li> <li>• 1 message structure error code added</li> </ul>
3.4	21-3-2016	Manon Havinga	<ul style="list-style-type: none"> <li>• Textual adjustments to align all MIGs</li> <li>• Functional error code added: E2030, E2034, E2035</li> <li>• Functional error code adjusted because of not being unique: E2032, E2033</li> <li>• Functional error code adjusted because described situation is not possible in reality: E2034</li> <li>• Applicability of MailingWrapperTypeCode adjusted</li> <li>• Message structure code E012 combined with E009</li> <li>• Dependence requirements adjusted of ItemID, ConsignmentCharacteristics, PhysicalDataFormatCode,</li> </ul>





			<p>PhysicalDataLength, PhysicalDataWidth, PhysicalDataThickness, PhysicalDataThicknessClass, AddressLabelingTypeCode, MailingWrapperTypeCode, PhysicalDataProductWeight, PhysicalDataTotalWeight.</p> <ul style="list-style-type: none"> <li>• Delivery date / delivery periode is made part of the request message and added functional error codes E2036 – E2040</li> </ul>
3.5	13-4-2016	Manon Havinga	<ul style="list-style-type: none"> <li>• Improved applicability: In the event that a value is supplied for an element which is “N/A”, then the value will be ignored instead of generating an error message.</li> <li>• Updated diagrams in paragraph 2.1</li> <li>• Introduction of MergedFromConsignmentID</li> </ul>
3.6	8-11-2016	Jaco Oskam	Extensions for T&C and T&C functionality.
3.7	15-3-2019	Remco van der Zon	<ul style="list-style-type: none"> <li>• Adjusted, size of ContractDescription</li> <li>• Adjusted, dependency requirements of ConsignmentIssueNumber</li> <li>• No longer in use, but still mentioned: ContractID, ContractPositionID, ContractPeriodicalName, ConsignmentAuthorizationNumber</li> <li>• Added: ConsignmentDeliveryTimePeriod</li> <li>• Added: Section with returnvalues of the validation.</li> </ul>
3.8	3-2-2020	Jacco L. Moens	<ul style="list-style-type: none"> <li>• Added new Error codes;</li> <li>• E2100, E2101, E2102</li> <li>• Toevoegen gebruik WSDL</li> </ul>
<a href="#">3.9</a>	<a href="#">1-5-2020</a>	<a href="#">Jacco L. Moens</a>	Toevoeging MyMail in de processingCharacteristics
3.10	23-6-2020	Jacco L. Moens	<ul style="list-style-type: none"> <li>• Heringebruikneming PeriodicalName en ConsignmentAuthorizationNumber</li> <li>•</li> </ul>
3.11	4-7-2020	Jacco L. Moens	<ul style="list-style-type: none"> <li>• Escaped characters toegevoegd</li> </ul>
3.12	7-8-2020	Jacco L. Moens	<ul style="list-style-type: none"> <li>• Error meldingen E2042 en E2043 toegevoegd</li> </ul>

Next page





4.0	9-6-2021	Frank Weusten	<p>New product model (1voud)</p> <ul style="list-style-type: none"> <li>• 5.9.2 Commercial Product added</li> <li>• 5.9.1 Definition sap product code changed</li> <li>• 5.9.3 ContractID reintroduced (replaces contract description), altered definition (no longer numeric)</li> <li>• 5.9.6.2 Consignment Processing Characteristics become obsolete.</li> </ul>
4.1	5-4-2022	Frank Weusten	<p>5.9.2 ReturnToParty: return address                      5.9.3.2.2.1 Commercial Services defined for return services                      5.9.3.2.2.1 Commercial Services Mixed splitted changed                      5.9.7.2 Return services for old product model                      5.9.8 Additional rules for Product Weight and Total Weight for mixed products                      5.9.8 ConsignmentPhysicalData must be used in alphabetical order. Items are placed in alphabetical order.</p>
4.2		Frank Weusten	<p>5.9.x Mymail picture in next version                      Consignment in alphabetical order                      5.9.3.2 ContractPositionID removed. Obsolete item.</p>
4.3		Frank Weusten	<p>5.9.11 Status field of consignment added. Can be used to cancel/delete consignments.                      6.3 Validation messages added.                      6.3.1 Validation messages added</p>





## Distribution

Who	Function
PostNL V&S team	B2B webservice development
Bulkmail webservice customers	Customers that use the Bulkmail webservice
Potential Bulkmail webservice customers	Customers interested in or developing for the Bulkmail webservice. For version 2.2 of this document, these are IntraPost and Pondres.

Copyright Koninklijke PostNL BV. © Den Haag

No part of this publication may be reproduced and / or published (for whatever purpose) by means of print, photocopy, microfilm, audio tape, electronically or in any other form whatsoever without the prior written permission of Koninklijke PostNL BV. This report is intended for internal use only for the company / companies listed above.

*This document is based on MIG Template version 1.0, March 1<sup>st</sup>, 2013*





## Table of Contents

<b>1</b>	<b>Introduction</b>	<b>8</b>
1.1	Functional definition	8
1.2	Principles	9
1.3	Field of application	9
1.4	PostNL canonical model	9
1.5	Conventions	9
1.6	References	11
<b>2</b>	<b>Interaction specification</b>	<b>12</b>
2.1	Interaction diagram	12
2.2	Channel, protocol and security	15
2.3	Escaped characters	15
<b>3</b>	<b>Operational interface management</b>	<b>16</b>
3.1	Frequency and volume	16
3.2	Validation and processing	16
3.3	Scheduling	16
3.4	Interface monitoring	16
3.5	Restart and recovery procedures	16
<b>4</b>	<b>Bulk Mail Order processing</b>	<b>17</b>
4.1	Pre-advice bulk mail order	17
4.2	Tender bulk mail order	18
4.3	Common elements for the different BulkMailOrder meanings	19
4.3.1	ErrorMessages	20
<b>5</b>	<b>Information model for Bulk Mail Order</b>	<b>22</b>
5.1	DocumentID	23
5.2	AlternateDocumentID	24
5.3	Attachment	25
5.4	Status	27
5.5	CustomerParty	29
5.5.1	PartyID	30
5.6	ShippingParty	31
5.6.1	PartyID	32
5.7	WorkLocation	33
5.8	MergeConsignmentIndicator	34





5.9	Consignment	35
5.9.1	CommercialProduct	38
5.9.2	ConsignmentCharacteristics	44
5.9.3	ConsignmentContract	45
5.9.4	ConsignmentPhysicalData	48
5.9.5	ConsignmentProcessing	57
5.9.6	CustomerConsignment	66
5.9.7	ItemID	68
5.9.9	PictureAttachment	71
5.9.10	ReturnTo Party	71
5.9.11	Status	73
6	Error handling	75
6.1	Success	75
6.2	Message structure error codes and messages	75
6.3	Validation and functional error codes and messages	76
6.3.1	Validation error codes	79



# 1 Introduction

This document provides the definition of the PostNL AddressAttachment message to be used in the electronic data conversation with the PostNL MijnPost B2B system. This Message Implementation Guidelines document is based on the AddressAttachment.xsd.

*The associated XSD with this MIG contains more elements/fields than described in this MIG. This is not an error but caused by the fact that we use standard elements which (can) contain more sub elements and/or fields than strictly necessary for this specific service. The reason for the use of a generic XSD is that future enhancements and changes can be easily implemented.*

*The associated XSD with this MIG contains elements/fields that will not be used. However it is required that all elements/fields described in this MIG are implemented in the messages exchanged between the different parties.*

*The current definition of the message, as described in this guideline, reflects its use in PostNL MijnPost. It does not preclude the use of this message between other organisational units or parties than those indicated in this guideline. The criteria for the use of the message should be its functionality rather than the organisational units or parties involved.*

*The XSD and WSDL prelude a different order than this MIG. Do not implement the PreAdvice and Tender bulkmail order according to the order in this MIG but based on the WSDL and XSD.*

## 1.1 Functional definition

The B2B module handles several messages including the BulkMailOrder message. The BulkMailOrder object structure supports both a bulk mail order as well as multiple bulk mail consignments.

The BulkMailOrder message is initially used to pre-advise one or multiple bulk mail consignments. The shipping party sends the data of the bulk mail consignment(s) to PostNL and the systems of PostNL generate a unique ConsignmentID and IssueID for each bulk mail consignment. A bulk mail consignment can be pre-adviced multiple times to report changes that are encountered after initially pre-advicing the bulk mail consignment and before tendering the bulk mail consignment. When the same bulk mail consignment (same ConsignmentID) is pre-adviced repeatedly, every pre-adviced of this bulk mail consignment is considered an update.

Before a bulk mail consignment is physically tendered at a PostNL location it must first be tendered administratively using the B2B webservice. Multiple bulk mail orders can be tendered at the same time. When a bulk mail order is tendered, it is considered final for PostNL and PostNL expects this bulk mail consignment at a PostNL location on the specified shipping date. When tendering, an



order is created in the PostNL systems and the B2B webservice returns a unique bulk mail order number and a P1700 form that is used when physically tendering the consignment.

A bulk mail order consists of one or multiple bulk mail consignments. Bulk mail consignments are grouped into bulk mail orders when these are tendered. Bulk mail orders with the same customer party, shipping party, service level, shipping date and tender location are grouped within a single order.

A shipping party acts on behalf of a customer party and a shipping party can pre-advise and tender one or multiple consignments for multiple customer parties.

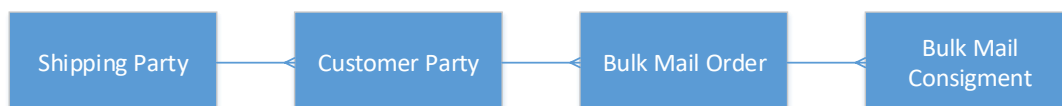

## 1.2 Principles

The BulkMailOrder message is exchanged to pre-advise or tender bulk mail consignments.

## 1.3 Field of application

The BulkMailOrder message is used by the system of a shipping party or customer party to pre-advise or tender bulk mail consignments. The message is communicated from customer systems to the MijnPost B2B module. See paragraph 2.1 for details about the message flow.

## 1.4 PostNL canonical model

The structure of the BulkMailOrder message is based on the definition of terms and conditions as agreed by PostNL. The definition of this message is based on existing canonical messages.

The BulkMailOrder message consists always of two components:

- A verb part, described in chapter 4 'Bulk Mail Order processing'
- A noun part, described in chapter 5 'Information Model for Bulk Mail Order'

## 1.5 Conventions

The following conventions apply in this document.

### Character type:

- a : string with alphabetic characters
- an : string with alphabetic and/or numeric characters
- n : string with numeric characters
- i : integer

d : decimal with decimal point as separator  
 boolean : "true" or "false"  
 dt : date time  
 guid : global unique identifier

Size:

Fixed : all positions must be used  
 Variable : positions may be used up to a specified maximum

Examples:

a3 : 3 alphabetic characters, fixed length  
 n3 : 3 numeric characters, fixed length  
 d4,3 : decimal, fixed length with 4 numeric characters left of the decimal separator and 3 numeric characters right of the decimal separator.  
 a..3 : up to 3 alphabetic characters  
 n..3 : up to 3 numeric characters  
 dt : 2011-01-20T13:35:32Z  
 guid : 55f1ebee-5d37-41be-b260-b07b1929a1f7

The following conventions apply when parts of the message are presented as an XSD model.

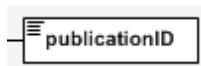

Box with a full line is a mandatory message element

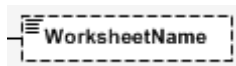

Box with a dotted line is an optional message element

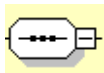

The component can contain a number of mandatory and optional elements. The elements must appear in the sequence mentioned

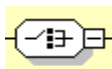

The component contains a number of elements. Only one of the possible elements may be present (choice).

Each message element is elaborated in this document using the format below.

Action	Description
Element	Name of the element
Description	Description of the element
Type and size	Type and size of the element. See the text above for the conventions
Formatting	Format of the element. For example a year has the format "YYYY"
Default value	Standard value of the element
Applicability	A meaning indicates how the message is handled by the MijnPost B2B module. For example the meaning "Show".

Action	Description
	<p>For each meaning is described whether the element is:</p> <ul style="list-style-type: none"> <li>• <b>Mandatory:</b> The element must have an allowed value. If a correct value is supplied, then MijnPost B2B module will check and register the supplied value. If no value or an incorrect value is supplied, then MijnPost B2B module will generate an error message.</li> <li>• <b>Optional:</b> The element doesn't have to have a value. If a value is supplied, then MijnPost B2B module will check and register the supplied value. If no value is supplied, then MijnPost B2B module doesn't perform any action.</li> <li>• <b>Not applicable (N/A):</b> The element shouldn't have a value. If a value is supplied, then MijnPost B2B module will ignore the supplied value and this value is not returned in the response. If no value is supplied, then MijnPost B2B module doesn't perform any action.</li> </ul>
Dependence requirements	Explanation of dependencies between this element and other elements

## 1.6 References

Reference	Details
[ref1]	MIG AddressAttachment message Jaco Oskam Version 2.2 November 8 <sup>th</sup> , 2016
[ref2]	MIG PackagingInformation message Jaco Oskam Version 2.1 April 13 <sup>th</sup> , 2016
[ref3]	MIG OrderConfirmation message <TBD>

## **2**      **Interaction specification**

This chapter describes the interactions with the MijnPost B2B module using an interaction diagram. In addition, technical aspects like protocol and channel are described.

### **2.1**      **Interaction diagram**

The next diagram shows the functional flows between customer systems and the MijnPost B2B module. Only the communications within the green box are in scope of this MIG.

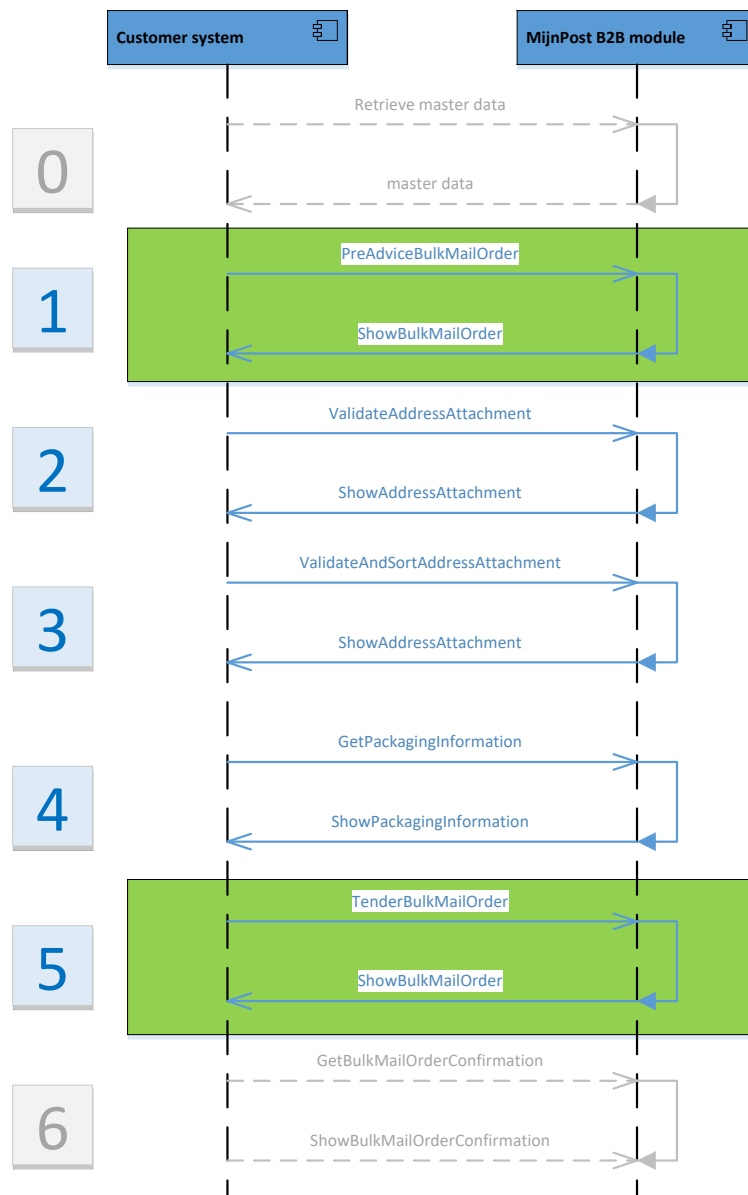

A typical customer flow for creating and tendering a bulk mail order based on a sorted product consists of 6 steps. When creating and tendering a bulk mail order for an unsorted product, specific steps are optional. The next figure indicates which steps are mandatory and optional for both sorted and unsorted products.

	Masterdata (0)	Pre-advise (1)	Validate (2)	ValidateAndSort (3)	Packaging Information (4)	Tender (5)	Order Confirmation (6)
sorted	optional	mandatory	optional	mandatory	optional	mandatory	optional
unsorted	optional	mandatory	optional	Not applicable	optional	mandatory	optional

Before a bulk mail order is created the applicable master data like geo data and location data can be downloaded from the MijnPost web portal. The B2B webservice does not offer any master data since the relevant master data is all relatively static and the same for all customers. When, in the future, more dynamic master data becomes relevant, the B2B webservice might be updated to supply these data.

Step 1 is to pre-advise the bulk mail order. Within that step consignments are created or updated. Multiple consignments can be pre-adviced within a single invocation. As a result, unique ConsignmentID(s) and unique IssueID(s) are returned of which ConsignmentID(s) must be used for further processing. The PreAdviceBulkMailOrder method can be invoked multiple times. When an existing ConsignmentID is used, the existing consignment gets updated. Otherwise a new consignment is created.

Bulk mail orders are sent to many addressee. When a customer has an address file containing these addressee, the addresses within this file can be validated in step 2. Validation is mandatory for sorted products and optional for unsorted products. Validation can be executed separately or in combination with sorting (step 3). When ConsignmentID is present, addresses can be validated. Validation includes categorizing addresses in domestic, foreign and unrecognized. Validation and sorting is only supported on a single address file at a time.

After validating addresses, the addresses can be sorted. This applies to bulk mail orders with sorted products only. During sorting in step 3, each individual address is also enriched with a sorting code. See [ref1] for details about the *AddressAttachment* message that is used for validation and sorting.

Bulk mail orders are packaged into bundles and roller cages or pallets. Based on the sorting result, a set of packaging forms, that can be printed to label the packaging materials, can be retrieved in step 4. This step requires the unique ConsignmentID that was returned in step 1 and is mandatory for sorted products and optional for unsorted products. See [ref2] for details about the *PackagingInformation* message that is used to retrieve the packaging forms.

Bulk mail consignments are tendered in step 5 and this results in one or multiple bulk mail orders. ConsignmentID is mandatory. Bulk mail consignments can only be tendered after pre-advicing the

bulk mail consignments first. Bulk mail consignments based on a sorted product can only be tendered after validating and sorting the related address file.

The result of a tender is a customer order number and a P1700 form that must be used when physically tendering the bulk mail order at a PostNL location.

It is important to notice that the B2B module is realized as a webservice so all interactions exist of request and responses. The customer system is always the requesting party and the B2B module replies. This is summarized in the next table for the bulk mail order functionality.

Request	Response
PreAdviceBulkMailOrder	ShowBulkMailOrder
TenderBulkMailOrder	ShowBulkMailOrder

After physically tendering the bulk mail order, a confirmation of the order can be retrieved in step 6. This is the final step of the functional flow. Getting the order confirmation is optional. See [ref 3] for details about the *OrderConfirmation* message.

This message hasn't been implemented yet. The B2B webservice will be updated in future to supply also these data.

The remainder of this document only describes the highlighted part of the interaction diagram.

## 2.2 Channel, protocol and security

The MijnPost B2B module offers its functionality as a SOAP webservice. It is consumed over an HTTPS connection. The calling party (customer system) identifies itself using a client certificate.

## 2.3 Escaped characters

When using SoapUI you should escape the following characters;

Special character	escaped form	gets replaced by
Ampersand	&amp;	&
Less-than	&lt;	<
Greater-than	&gt;	>
Quotes	&quot;	"
Apostrophe	&apos;	'

## **3** Operational interface management

### **3.1 Frequency and volume**

Bulk mail consignments are created throughout the day and can be pre-advised and tendered throughout the day (24\*7 support). A maximum of 250 consignments can be pre-advised or tendered within a single invocation.

### **3.2 Validation and processing**

Before the message is processed it will be validated by the receiving party (MijnPost B2B module) on multiple levels:

1. Structure and field definitions
2. Contents and syntax
3. Meaning and semantics

Result of validation is either OK or not OK.

When an error is detected, the complete message is rejected. The sending party must repair the message based on the supplied error code(s) and resend the message.

### **3.3 Scheduling**

Not applicable.

### **3.4 Interface monitoring**

Monitoring takes place on a daily basis and involves:

- Tracking the total number of received messages
- Detect abnormalities
- Investigate abnormalities
- Verify that the webservice is up and running

### **3.5 Restart and recovery procedures**

This will be according to the standard system maintenance of MijnPost.NET modules.



## 4 Bulk Mail Order processing

The BulkMailOrder message supports two meanings:

- PreAdvice
- Tender

A meaning indicates how the BulkMailOrder message is handled by the MijnPost B2B module. Both meanings support only a single BulkMailOrder object within a single invocation. PreAdvice always returns a single BulkMailOrder object while Tender may return multiple BulkMailOrder objects.

### 4.1 Pre-advice bulk mail order

Bulk mail consignments must be pre-advised before addresses can be validated (and sorted) and before a bulk mail consignment can be tendered. Bulk mail consignments are pre-advised and not bulk mail orders although the BulkMailOrder object is used. Only bulk mail consignments that:

- belong to a single customer party **AND**
- have the same shipping date **AND**
- are physically tendered at the same PostNL location,

can be pre-advised within a single action.

When the validation of the BulkMailOrder message succeeds, new bulk mail consignments are created and/or existing consignments are updated in the PostNL systems. The response of the pre-advice action contains a unique ConsignmentID and IssueID for each created consignment. The consignments are still within the context of the single BulkMailOrder object. The next figure depicts this graphically:

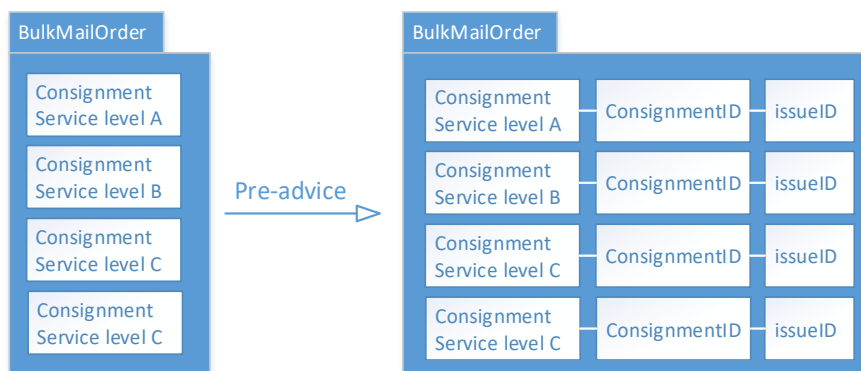

An existing consignment (that has been pre-advised before) is recognized based on the supplied unique ConsignmentID that was returned when this consignment was created before.

When a sorted product is defined for a consignment and an address file has been validated and sorted, it is still possible to change some parameters of the consignment. Which fields cannot be changed (or changed in a specific manner) will be specified below.

When validation fails, no consignment(s) are created or updated. The response contains an error code as described in chapter 6.

#### 4.2 Tender bulk mail order

Bulk mail consignments are tendered whereas bulk mail orders are not, although the BulkMailOrder object is used. Bulk mail consignments can be tendered after these have been pre-advised before. When a sorted product is defined for a consignment, an address file must have been validated and sorted and packaging information must have been retrieved before tendering the consignment. Bulk mail consignments can be tendered only once. An input parameter to the tender action defines whether or not to combine multiple bulk mail consignments into a single consignment. Before tendering, the bulk mail consignments are updated when applicable.

Only a bulk mail order that contains bulk mail consignments that:

- belong to a single customer party **AND**
- have the same shipping date **AND**
- are physically tendered at the same PostNL location,

can be tendered within a single action.

Additional bulk mail order(s) originate when bulk mail consignments with different service levels are tendered. The B2B webservice creates multiple orders for consignment that differ in service level:

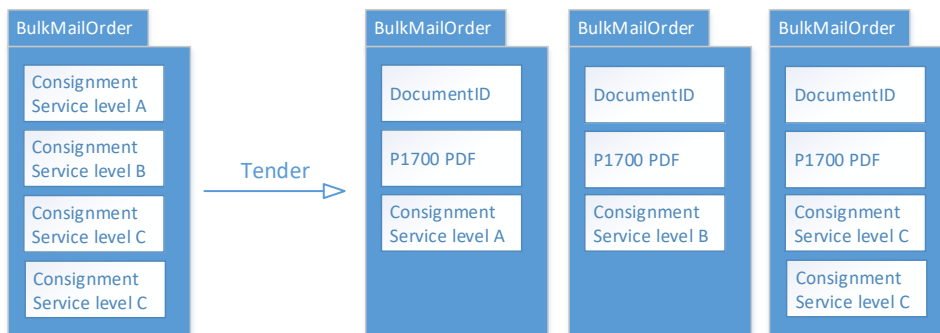

When the validation of the BulkMailOrder message succeeds, the existing bulk mail consignments are tendered. The response of the tender action contains a unique bulk mail order number (DocumentID) for each bulk mail order and a P1700 form for each bulk mail order.

When validation fails, no consignment(s) are updated and tendered. The response contains an error code as described in chapter 6.

### 4.3 Common elements for the different BulkMailOrder meanings

The meanings described above share some common elements which are required in the header of the message. Only the relevant items within the header are described in the next table. Items that are not listed are not applicable, will be ignored and do not have to be present in the message.

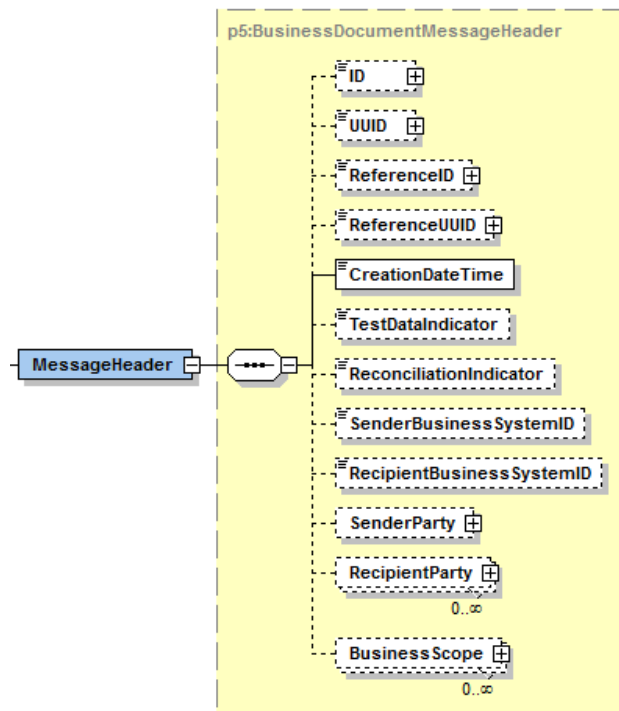

Action	Description
Element	CreationDateTime
Description	Timestamp when the message was created.
Type and size	datetime
Formatting	[0-9]{4}-[0-9]{2}-[0-9]{2}T[0-9]{2}:[0-9]{2}:[0-9]{2}(.{0-9}{1,7})?Z
Default value	N/A
Applicability	
PreAdviceBulkMailOrder	Mandatory
Show	Mandatory
TenderBulkMailOrder	Mandatory
Show	Mandatory
Dependence requirements	None

Action	Description
Element	TestDataIndicator
Description	Indicates whether or not this message should be <ul style="list-style-type: none"> <li>- fully processed (false)</li> <li>- only checked (true)</li> </ul>
Type and size	boolean
Formatting	true or false
Default value	false
Applicability	
PreAdviceBulkMailOrder	Optional
Show	Optional
TenderBulkMailOrder	Optional
Show	Optional
Dependence requirements	When the TestDataIndicator is true, no actual result is returned. Only the structure of the messages is checked including the check on mandatory message elements and message element types and values. No consignments are created, updated or tendered in the PostNL systems.

This default header contents is extended with an error messages section. Within this section all error messages regarding the structure of the message will be logged. A list of these messages can be found in section 6.1.

Functional error messages regarding the state of the BulkMailOrder object itself are part of the message body described in chapter 5.

#### 4.3.1 ErrorMessages

The ErrorMessages structure depicted below is added to the header of the message.

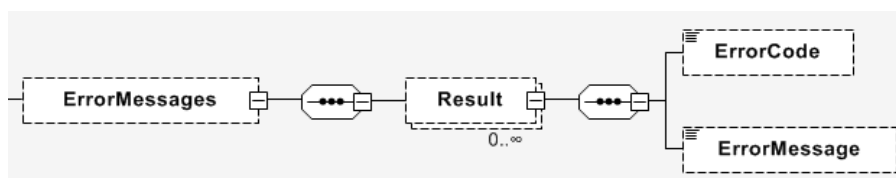

Both ErrorMessages and Result are not data elements themselves but components that hold data elements. The ErrorMessages component can hold zero to many Result components. Each Result component holds one specific ErrorCode element and one ErrorMessage element.

Action	Description
Element	ErrorCode
Description	A code that uniquely identifies the error that occurred when a bulk mail order was pre-advised or tendered. A specific error code is returned when no error occurred. See chapter 6 for all supported error codes.
Type and size	a1 or an5
Formatting	Success: S Error: Ennnn, for example "E0008"
Default value	N/A
Applicability	
PreAdviceBulkMailOrder	N/A
Show	Mandatory
TenderBulkMailOrder	N/A
Show	Mandatory
Dependence requirements	ErrorCode and ErrorMessage relate to each other.

Action	Description
Element	ErrorMessage
Description	A text message that explains the error that occurred.
Type and size	a
Formatting	Text "Success" when no error occurred. See chapter 6 for all supported error messages.
Default value	N/A
Applicability	
PreAdviceBulkMailOrder	N/A
Show	Mandatory
TenderBulkMailOrder	N/A
Show	Mandatory
Dependence requirements	ErrorCode and ErrorMessage relate to each other.

# 5 Information model for Bulk Mail Order

All relevant items within the message body are described in this chapter. Items that are not listed in this chapter but are present in the message structure (XSD) are not applicable for this appliance, will be ignored, and do not have to be present in the message.

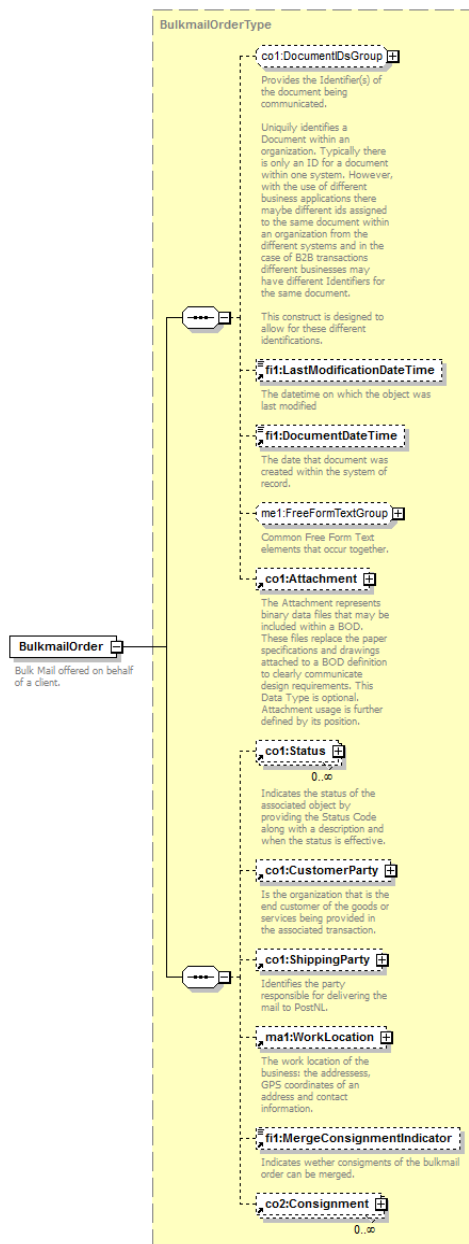

The PreAdviceBulkMailOrder and TenderBulkMailOrder requests exists of a message header as described in chapter 4 and message content as described in this chapter. Message content is a single BulkMailOrder. The PreAdviceBulkMailOrder response also contains a single BulkMailOrder. The TenderBulkMailOrder response contains 1-n BulkMailOrder objects.

## 5.1 DocumentID

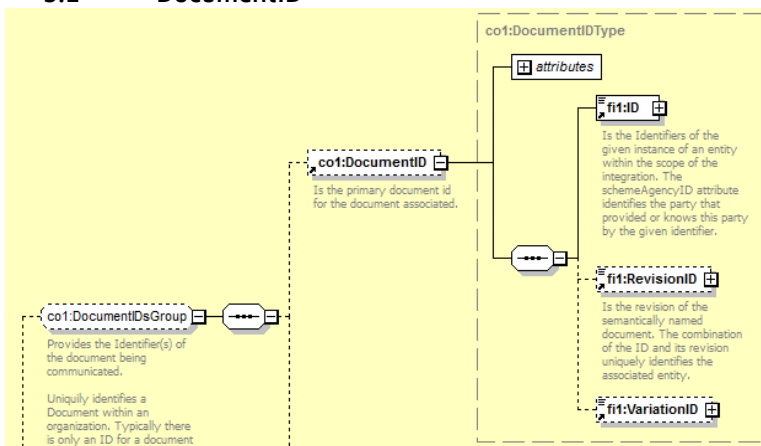

Action	Description
Element	ID
Description	Unique customer order number that is assigned to a bulk mail order when it is created in the PostNL systems (when tendering a bulk mail order).
Type and size	n12
Formatting	N/A
Default value	N/A
Applicability	
PreAdviceBulkMailOrder	N/A
Show	N/A
TenderBulkMailOrder	N/A
Show	Mandatory
Dependence requirements	<p>Although only consignments with the same:</p> <ul style="list-style-type: none"> <li>customer party <b>AND</b></li> <li>shipping date <b>AND</b></li> <li>tender location</li> </ul> <p>are allowed to be tendered within a single invocation it is still possible that multiple customer orders are created. A customer order is created for each different service level.</p>

Action	Description
	These bulk mail orders are returned as separate containers in the response. Each BulkMailOrder object contains a unique DocumentID and a related P1700 form (see section 5.3).

## 5.2 AlternateDocumentID

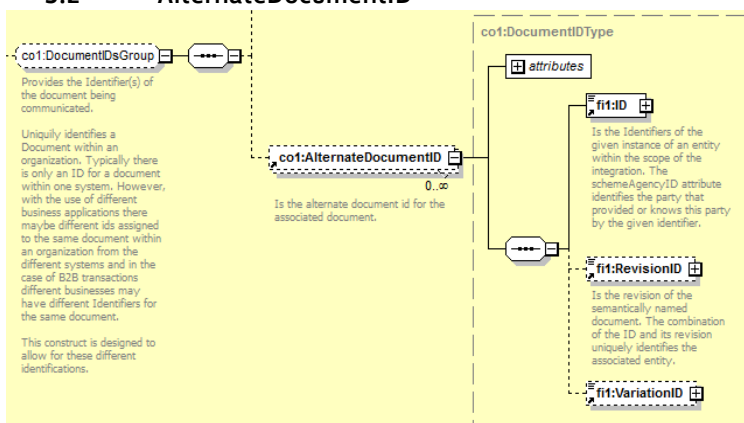

Action	Description
Element	ID
Description	Customer reference. This value is not stored in a PostNL system. It is returned unmodified in the response to the request.
Type and size	a
Formatting	N/A
Default value	N/A
Applicability	
PreAdviceBulkMailOrder	Optional
Show	Optional
TenderBulkMailOrder	Optional
Show	Optional
Dependence requirements	This field has no relation with DocumentID.



### 5.3 Attachment

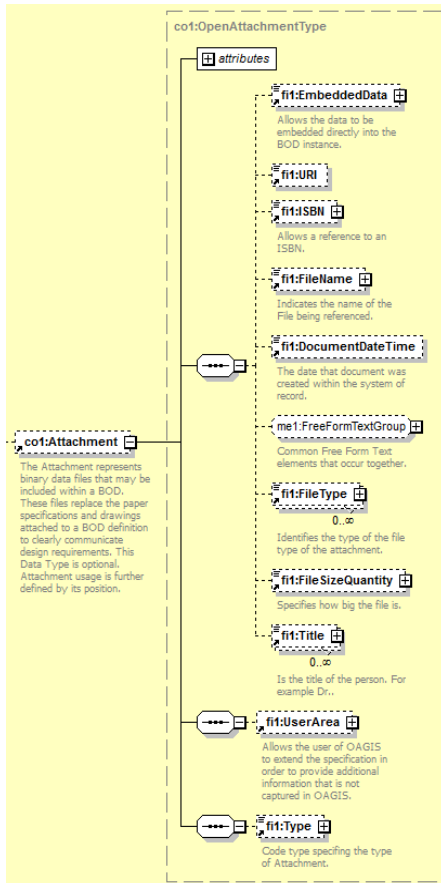

Action	Description
Element	EmbeddedData
Description	P1700 form as PDF file. This PDF lists all consignments on this order.
Type and size	an
Formatting	base64 encoded file
Default value	N/A
Applicability	
PreAdviceBulkMailOrder	N/A
Show	N/A
TenderBulkMailOrder	N/A
Show	Mandatory
Dependence requirements	See section 5.1.

Action	Description
Element	FileName
Description	Name of the P1700 PDF file.
Type and size	a
Formatting	"<DocumentID>.pdf"
Default value	N/A
Applicability	
PreAdviceBulkMailOrder	N/A
Show	N/A
TenderBulkMailOrder	N/A
Show	Mandatory
Dependence requirements	None

Action	Description
Element	FileType
Description	Output file type is always a PDF file.
Type and size	a3
Formatting	"PDF"
Default value	N/A
Applicability	
PreAdviceBulkMailOrder	N/A
Show	N/A
TenderBulkMailOrder	N/A
Show	Mandatory
Dependence requirements	None

## 5.4 Status

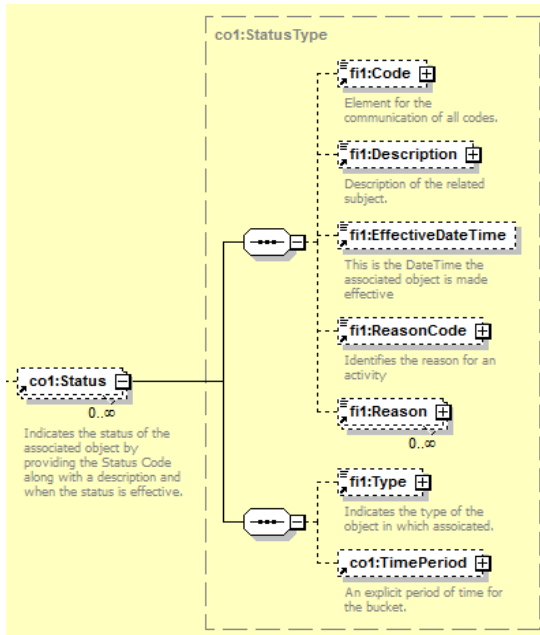

The Status section is used to supply status information about the BulkMailOrder object. Two statuses can be distinguished:

- **Success**, action completed without errors.
- **Error** when an error occurred during message processing.

Currently, this field is not used. The status of the handling of a BulkMailOrder object is reported in the header of the response as described in section 4.3.1.

Action	Description
Element	Code
Description	Currently, this field is not used. The status of the handling of a BulkMailOrder object is reported in the header of the response as described in section 4.3.1.
Type and size	Success: a1 Error: an5
Formatting	Success: "S" Error: <Ennnn>, for example "E0009"
Default value	N/A
Applicability	
PreAdviceBulkMailOrder	N/A
Show	Optional

Action	Description
TenderBulkMailOrder	N/A
Show	Optional
Dependence requirements	Code and Description relate to each other.

Action	Description
Element	Description
Description	A text message that explains the Code.
Type and size	a
Formatting	Success: "Success". Error: a text explaining the error.
Default value	N/A
Applicability	
PreAdviceBulkMailOrder	N/A
Show	Optional
TenderBulkMailOrder	N/A
Show	Optional
Dependence requirements	Code and Description relate to each other.

## 5.5 CustomerParty

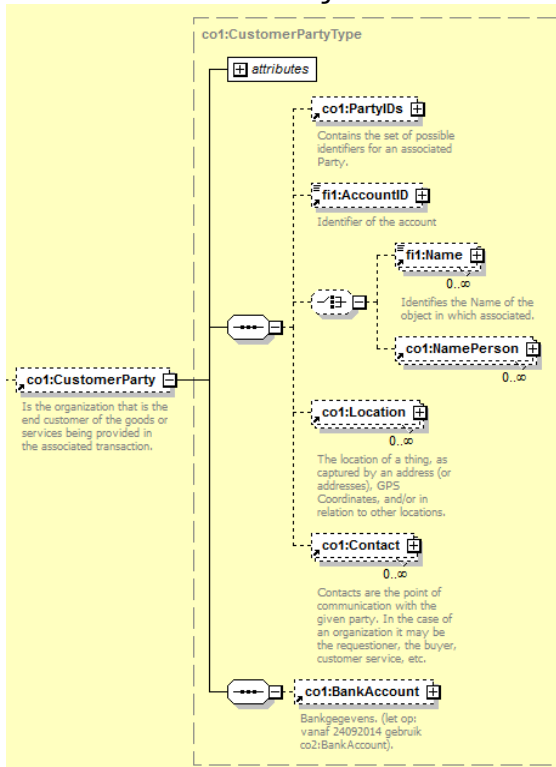

There is a difference between the Customer Party and the Shipping party when considering the BulkMailOrder object.

The Customer Party element represents the PostNL customer for which the consignment is pre-advised or tendered. It is the customer that pays for the bulk mail order.

The Shipping Party element represents the PostNL customer that invokes the B2B webservice on behalf of the Customer Party.

Naturally, Customer Party and Shipping Party can be the same entity.

## 5.5.1 PartyID

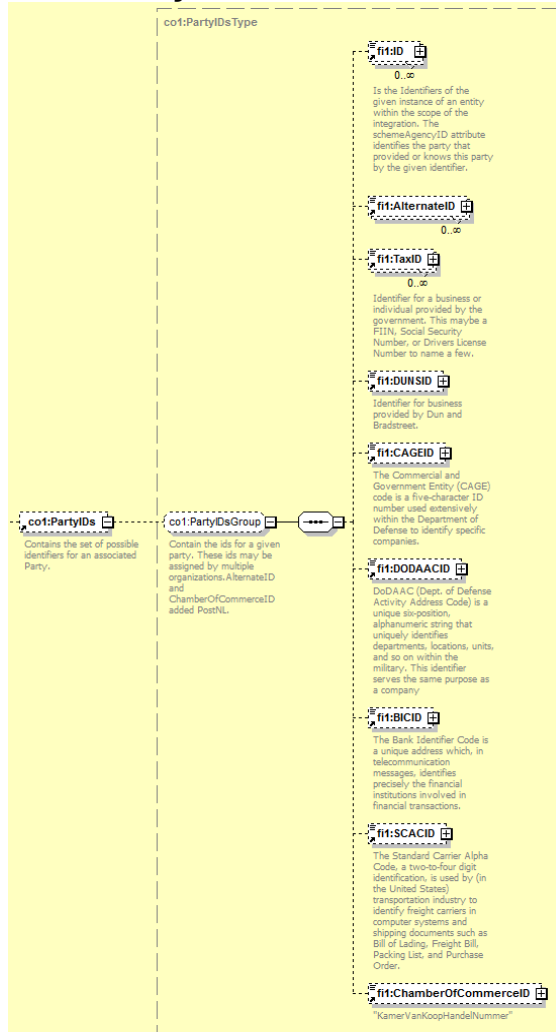

Action	Description
Element	ID
Description	Customer number that identifies the customer uniquely.
Type and size	n1..16
Formatting	N/A
Default value	N/A
Applicability	
PreAdviceBulkMailOrder	Mandatory
Show	Mandatory
TenderBulkMailOrder	Mandatory

Action	Description
Show	Mandatory
Dependence requirements	None.

## 5.6 ShippingParty

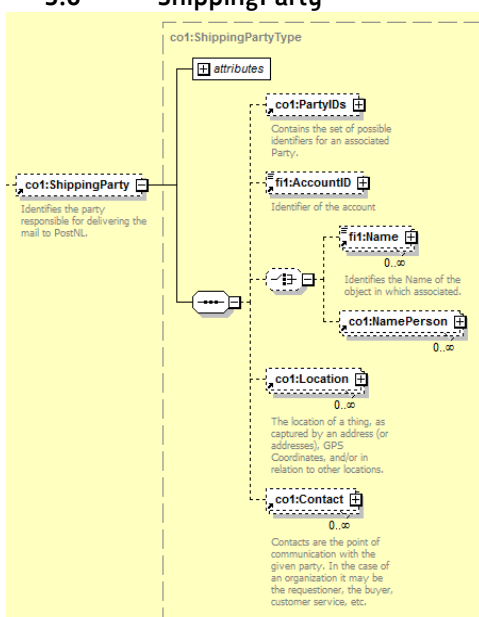

There is a difference between the Customer Party and the Shipping party when considering the BulkMailOrder object.

The Customer Party element represents the PostNL customer for which the consignment is pre-advised or tendered. It is the customer that pays for the bulk mail order.

The Shipping Party element represents the PostNL customer that invokes the B2B webservice on behalf of the Customer Party.

Naturally, Customer Party and Shipping Party can be the same entity.

## 5.6.1 PartyID

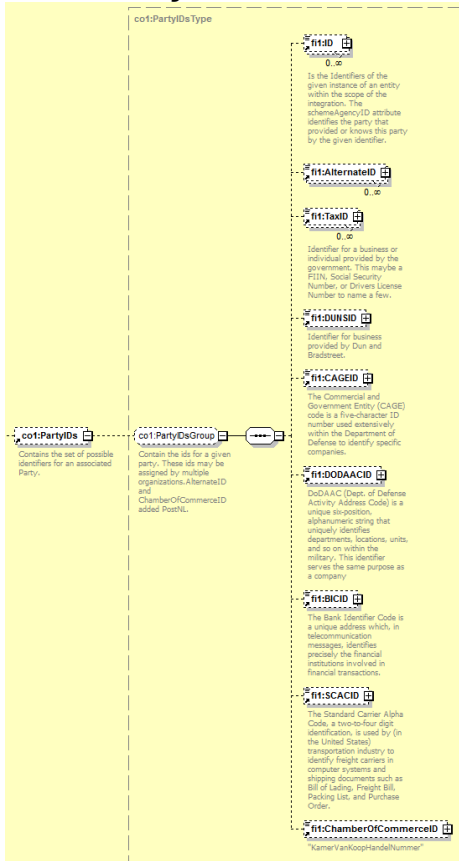

Action	Description
Element	ID
Description	Customer number that identifies the shipping customer uniquely.
Type and size	n1..16
Formatting	N/A
Default value	N/A
Applicability	
PreAdviceBulkMailOrder	Mandatory
Show	Mandatory
TenderBulkMailOrder	Mandatory
Show	Mandatory
Dependence requirements	None.



## 5.7 WorkLocation

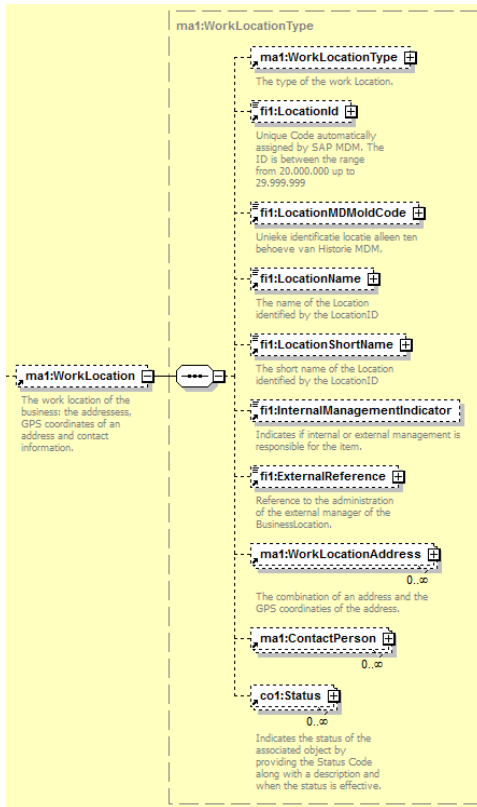

Action	Description
Element	LocationId
Description	Unique identification of the PostNL location where the consignment will be tendered.
Type and size	an..20
Formatting	N/A
Default value	N/A
Applicability	
PreAdviceBulkMailOrder	Mandatory
Show	Mandatory
TenderBulkMailOrder	Mandatory
Show	Mandatory
Dependence requirements	LocationId values are supplied as master data.

### 5.8 MergeConsignmentIndicator

Action	Description
Element	MergeConsignmentIndicator
Description	The customer indicates whether or not to try to combine all possible consignments.
Type and size	boolean
Formatting	true or false
Default value	true
Applicability	
PreAdviceBulkMailOrder	N/A
Show	N/A
TenderBulkMailOrder	Optional
Show	Optional
Dependence requirements	

## 5.9 Consignment

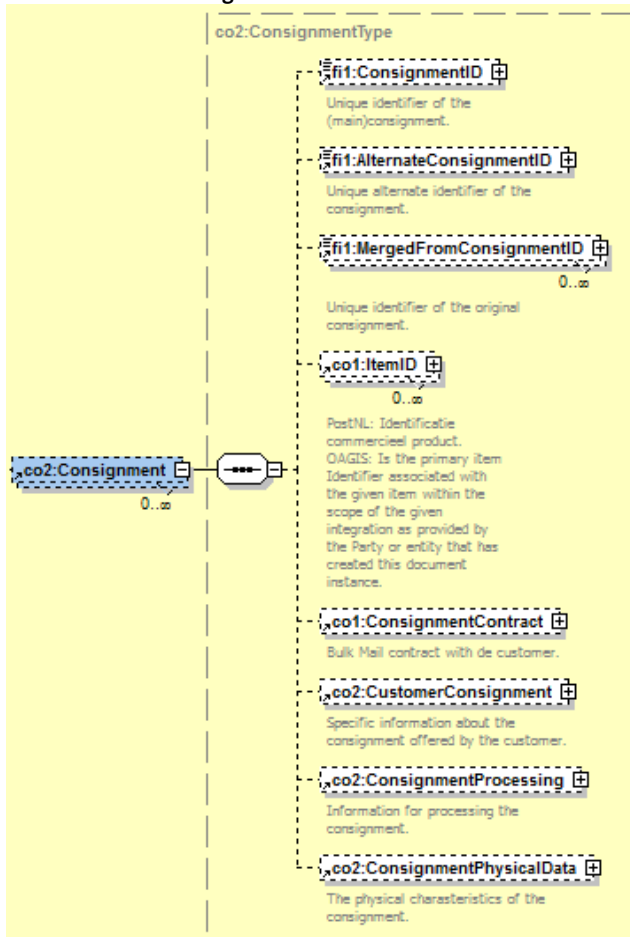

The BulkMailOrder message contains 1 or multiple consignments.

Action	Description
Element	ConsignmentID
Description	A unique identification of a consignment.
Type and size	n12
Formatting	N/A
Default value	N/A
Applicability	
PreAdviceBulkMailOrder	N/A when a consignment is pre-advised for the first time. Mandatory when a consignment is pre-advised again.
Show	Mandatory
TenderBulkMailOrder	Mandatory

Action	Description
Show	Mandatory
Dependence requirements	<p>A consignment can be pre-advised multiple times. Each additional pre-advice overrules previous pre-advises and the consignment is updated in the PostNL systems. When an existing consignment is pre-advised again, the ConsignmentID must be present. If not, a new consignment is created in the PostNL systems.</p> <p>Consignments can only be tendered once. Tendering a consignment repeatedly results in an error.</p> <p>When the MergeConsignmentIndicator (see above) is used in the TenderBulkMailOrder-message and a merge combination is possible, then the possible consignments are combined into this new consignment with it's own unique consignment ID.</p>

Action	Description
Element	AlternateConsignmentID
Description	Customer reference related to this consignment. This customer reference is not stored in PostNL systems. Any supplied value in a request is returned unmodified in the response.
Type and size	an
Formatting	N/A
Default value	N/A
Applicability	
PreAdviceBulkMailOrder	Optional
Show	Optional
TenderBulkMailOrder	Optional
Show	Optional
Dependence requirements	None

Action	Description
Element	MergedFromConsignmentID
Description	<p>A unique identification of a consignment.</p> <p>This is the unique identifier of the original consignment, in case the original consignment was merged together with other original consignments into a new merged consignment.</p>
Type and size	n12

Action	Description
Formatting	N/A
Default value	N/A
Applicability	
PreAdviceBulkMailOrder	N/A
Show	N/A
TenderBulkMailOrder	N/A
Show	Optional
Dependence requirements	<p>When the MergeConsignmentIndicator (see above) is used in the TenderBulkMailOrder-message and a merge combination is possible, then the possible consignments are combined into a new consignment with it's own unique consignment ID.</p> <p>The new consignment is shown in ConsignmentID (see above). The original consignments are presented here.</p> <p>There are always at least two MergedFromConsignmentID's per ConsignmentID.</p>

### 5.9.1 CommercialProduct

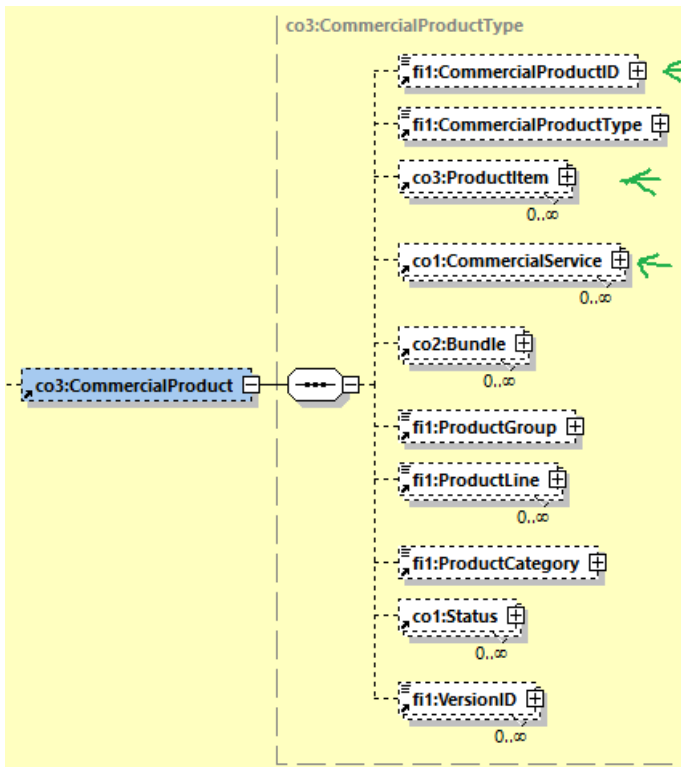

#### 5.9.1.1 CommercialProductID

Action	Description
Description	ID of the commercial product used
Multiplicity	1..1
Formatting	Value 20410 for PARTIJENPOST NL Value 20420 for PARTIJENPOST DM NL Value 20430 for PARTIJENPOST PERIODIEKEN NL Value 20440 for VERKIEZINGEN NL
Dependence requirements	N/A
Applicability	O (R for new product model)

### 5.9.1.2 ProductItem

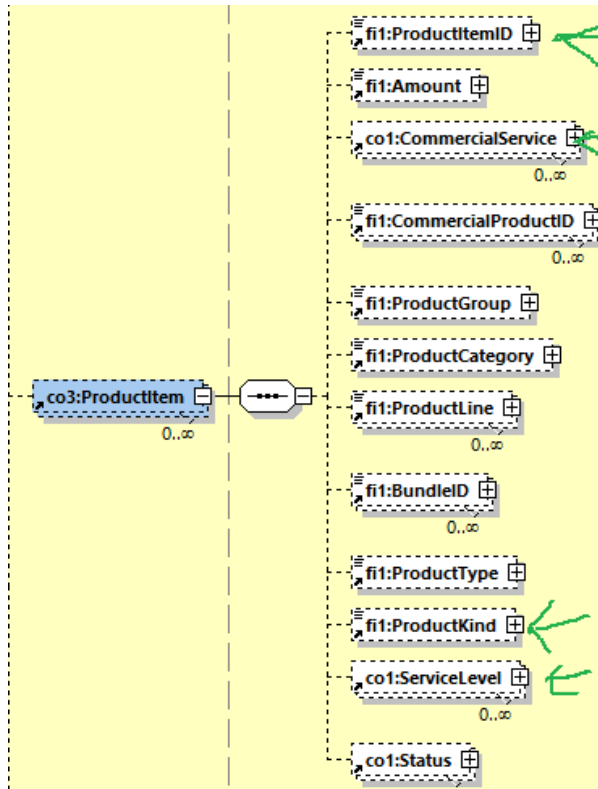

#### 5.9.2.2.1 ProductItemID

Action	Description
Description	The smallest single ProductItemID of the commercial Product used
Multiplicity	1..1
Formatting	New product model values: Value 7301 for KLEIN Value 7302 for GROOT Value 7303 for SPECIAAL Value 7304 for GEMENGD Value 7305 for GEMENGD EXTRA (goederen)
Dependence requirements	N/A
Applicability	O (R for new product model)

### 5.9.3.2.2 CommercialService

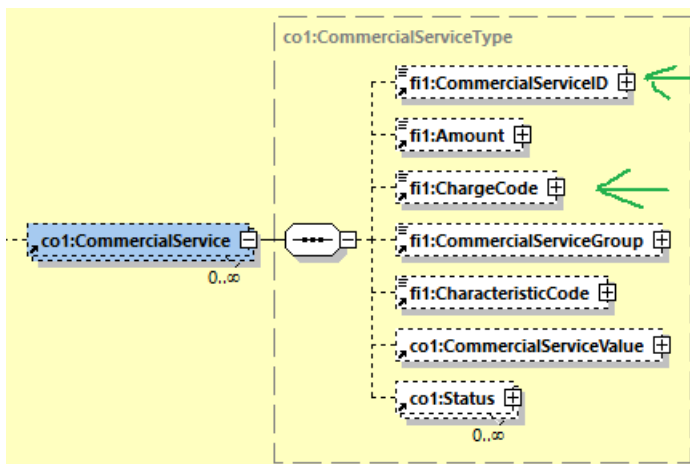

#### 5.9.3.2.2.1 CommercialServiceID

Action	Description
Description	The ID of the selected commercial service.
Multiplicity	0..N
Formatting	<p>Use services which are valid for a product.</p> <p>Exceptions</p> <p>One of these two is allowed:</p> <ol style="list-style-type: none"> <li>1. VPK006.009 for Coded (Coding line and 2D matrix on mail piece)</li> <li>2. DEP006.001 for Sorted (Print line on mail piece)</li> </ol> <p>One of these two is allowed:</p> <ol style="list-style-type: none"> <li>1. INF001.007 for Track Check</li> <li>2. INF002.014 for Mymail</li> </ol> <p>One return service choice is allowed</p> <ol style="list-style-type: none"> <li>1. INF002.016 digital return</li> <li>2. INF002.017 both digital and physical return</li> <li>3. INF002.018 physical return</li> </ol> <p>If one of these two is chosen</p> <ol style="list-style-type: none"> <li>1. INF001.007 Track&amp;Check</li> </ol>



	<p>2. INF002.014 Mymail</p> <p>Than VPK006.009 Gecodeerd (codeerregel + 2D matrix) is mandatory</p> <p>DEP006.009 for Mixed Separated (Sorting machine ready).</p>
Dependence requirements	N/A
Applicability	O (R for new product model)

## Combinaties van services

### Enkele spelregels. Ook in MIG beschreven.

Je mag maar 1 van beide in een consignment opnemen:

- VPK006.009 Gecodeerd (codeerregel + 2D matrix)
- DEP006.001 Gesorteerd, gecodeerd met printregel

Je mag maar 1 van beide in een consignment opnemen:

- INF001.007 Track&Check
- INF002.014 MyMail

Bij INF001.007 Track&Check en INF002.014 MyMail  
DAN:

- VPK006.009 Gecodeerd (codeerregel + 2D matrix) is verplicht. (uniek maken stukken)
- DEP006.001 Gesorteerd, gecodeerd met printregel is niet toegestaan.

Of  
Bij beide wel de codering meegeven op het poststuk

Coded	Sorted
VPK006.009	DEP006.001

Of  
In Mymail zit al trackandcheck

TrackAnd Check	Mymail
INF001.007	INF002.014

verplicht

Coded	Sorted	TrackAnd Check	Mymail	Mixed Separated
VPK006.009	DEP006.001	INF001.007	INF002.014	DEP006.007

NIET

Oplossingsrichting UI

Not coded	Coded	Sorted	TrackAnd Check	Mymail	Mixed Separated
	VPK006.009	DEP006.001	INF001.007	INF002.014	DEP006.007

Stap 1  
Default not coded

Stap 2  
Uitgrijzen totdat  
coded aan staat

10



### 5.9.3.2.2 ChargeCode

Action	Description
Description	The charge code of the selected commercial service.
Multiplicity	0..N (1..1 CommercialServiceID)
Formatting	
Dependence requirements	Required when CommercialServiceID is used

Applicability	NA will be processed within PostNL
---------------	------------------------------------

### 5.9.2.2.3 ProductKind

Action	Description
Description	The product kind of the selected product.
Multiplicity	1..1
Formatting	See product definitions.
Dependence requirements	N/A
Applicability	O (R for new product model)

### 5.9.3.2.4 ServiceLevel

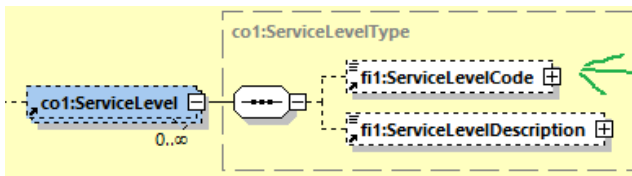

### 5.9.3.2.4.1 ServiceLevelCode

Action	Description
Description	The service level code of the selected product.
Multiplicity	1..1
Formatting	Values 1voud: NEXTDAY 48-72UUR NEXTWKFLEX
Dependence requirements	N/A
Applicability	O (R for new product model)

#### **5.9.3.2.4.1 ServiceLevelDescription**

Action	Description
Description	The service level description of the selected product.
Multiplicity	1..1
Formatting	Values:
Dependence requirements	N/A
Applicability	O

## 5.9.2 ConsignmentCharacteristics

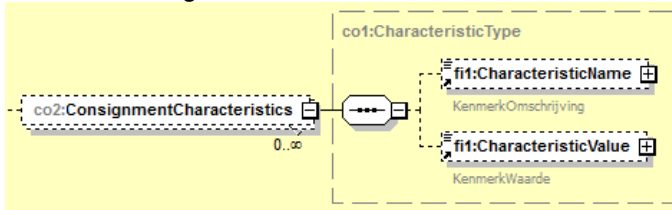

Consignment characteristics, also known as ORIKs (OrderRegel Identificatie Kenmerken) contain customer references. Three ORIKs are supported; only ORIK-1 is mandatory. The customer (Customer Party) defines whether or not ORIK-2 and ORIK-3 are used / mandatory.

Each consignment characteristic consists of a characteristic name (ORIK-1, ORIK-2 or ORIK-3) and the actual characteristic value.

Action	Description
Element	CharacteristicName
Description	Name of the ORIK.
Type and size	an6
Formatting	“ORIK-1” or “ORIK-2” or “ORIK-3”
Default value	N/A
Applicability	
PreAdviceBulkMailOrder	ORIK-1 is mandatory. ORIK-2 and ORIK-3 are optional.
Show	ORIK-1 is mandatory. ORIK-2 and ORIK-3 are optional.
TenderBulkMailOrder	ORIK-1 is mandatory. ORIK-2 and ORIK-3 are optional.
Show	ORIK-1 is mandatory. ORIK-2 and ORIK-3 are optional.
Dependence requirements	Only the presence of ORIK-1 is validated by the B2B service. Even when ORIK-2 and/or ORIK-3 are defined mandatory by the customer, the B2B service does not validate this.  When a sorted product is defined for a consignment and an address file has been validated and sorted, ORIK-1 and ORIK-3 (if supplied when pre-advised) are not allowed to be changed.

Action	Description
Element	CharacteristicValue
Description	Value of the ORIK.
Type and size	a..30
Formatting	N/A
Default value	N/A
Applicability	
PreAdviceBulkMailOrder	ORIK-1 is mandatory. ORIK-2 and ORIK-3 are optional.
Show	ORIK-1 is mandatory. ORIK-2 and ORIK-3 are optional.
TenderBulkMailOrder	ORIK-1 is mandatory. ORIK-2 and ORIK-3 are optional.
Show	ORIK-1 is mandatory. ORIK-2 and ORIK-3 are optional.
Dependence requirements	Only the presence of ORIK-1 is validated by the B2B service. Even when ORIK-2 and/or ORIK-3 are defined mandatory by the customer, the B2B service does not validate this.  When a sorted product is defined for a consignment and an address file has been validated and sorted, ORIK-1 and ORIK-3 (if supplied when pre-advised) are not allowed to be changed.

### 5.9.3 ConsignmentContract

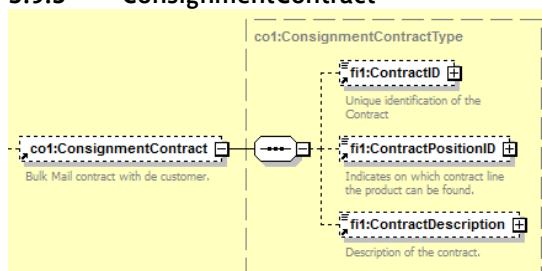

#### 5.9.3.1 ContractID

Action	Description
Element	ContractID
Description	Identification of a contract.
Type and size	Alpha numeric xx (xx: make reservation for at least 50 positions)

Action	Description
Formatting	N/A
Default value	N/A
Applicability	Not in use.
PreAdviceBulkMailOrder	N/A.
Show	
TenderBulkMailOrder	N/A
Show	
Dependence requirements	-

### 5.9.3.2 ContractDescription

Action	Description
Element	ContractDescription
Description	Description of a contract.
Type and size	a..80
Formatting	N/A
Default value	N/A
Applicability	
PreAdviceBulkMailOrder	Optional When periodical product: Mandatory
Show	Mandatory when the consignment is based on a product that requires a contract or when a ContractID was specified in the request. N/A otherwise.
TenderBulkMailOrder	Optional When periodical product: Mandatory
Show	Mandatory when the consignment is based on a product that requires a contract or when a ContractID was specified in the request. N/A otherwise.

Action	Description
Dependence requirements	<p>When no ContractDescription is supplied, the B2B webservice tries to find a contract when a consignment uses a product that requires a contract. When exactly 1 valid contract is found, it is used. Otherwise an error is reported. See <a href="#">6.3.1</a> for a list of return values.</p> <p>When ContractDescription is supplied, this is validated to exist <b>AND</b> to be related to:</p> <ul style="list-style-type: none"> <li>- the customer party <b>AND</b></li> <li>- the product code <b>AND</b></li> <li>- (DestinationZone <b>OR</b> DestinationCountryCode)</li> </ul>

## 5.9.4 ConsignmentPhysicalData



**Use the elements in alphabetical order as hown below and in WSDL:**

Action	Description
Element	AddressLabelingTypeCode
Description	Defines how the addressee is specified on each mail piece when MailingWrapperTypeCode "Foil" is used.
Type and size	n1
Formatting	Allowed values are: <ul style="list-style-type: none"> <li>1 Cheshire label</li> <li>2 Printed on appendix</li> <li>3 White foil</li> <li>4 Address label</li> </ul>
Default value	N/A



Action	Description
Applicability	
PreAdviceBulkMailOrder	Mandatory when MailingWrapperTypeCode equals 5 (“Foil”). N/A otherwise.
Show	Mandatory when MailingWrapperTypeCode equals 5 (“Foil”). N/A otherwise.
TenderBulkMailOrder	Mandatory when MailingWrapperTypeCode equals 5 (“Foil”). N/A otherwise.
Show	Mandatory when MailingWrapperTypeCode equals 5 (“Foil”). N/A otherwise.
Dependence requirements	When a sorted product is defined for a consignment and an address file has been validated and sorted AddressLabelingTypeCode (when applicable) is not allowed to be changed.

Action	Description
Element	MailingWrapperFinishingTypeCode
Description	Defines how the foil is closed when each mail piece is wrapped in foil.
Type and size	n1
Formatting	Allowed values are:
	1 (Lengthwise sealed)
	2 (Transversal sealed)
	3 (Shrink film)
	4 (Flap)
Default value	N/A
Applicability	
PreAdviceBulkMailOrder	Mandatory when MailingWrapperTypeCode equals 5 (“Foil”). N/A otherwise.
Show	Mandatory when MailingWrapperTypeCode equals 5 (“Foil”). N/A otherwise.
TenderBulkMailOrder	Mandatory when MailingWrapperTypeCode equals 5 (“Foil”). N/A otherwise.
Show	Mandatory when MailingWrapperTypeCode equals 5 (“Foil”). N/A otherwise.
Dependence requirements	None

Action	Description
Element	MailingWrapperTypeCode
Description	Defines the shell of each mail piece.
Type and size	n1..2
Formatting	Allowed values are: 5 (Foil) 9 (Self mailer) 23 (Label roll) 97 (Envelope) 98 (Card) 99 (Postal item with gadget/sample) <TBD> (Box) <TBD> (Other) <TBD> (No wrapper)
Default value	N/A
Applicability	
PreAdviceBulkMailOrder	Mandatory for consignments based on sorted products that have a commercial format other than "Mixed". N/A otherwise.
Show	Mandatory for consignments based on sorted products that have a commercial format other than "Mixed". N/A otherwise.
TenderBulkMailOrder	Mandatory for consignments based on sorted products that have a commercial format other than "Mixed". N/A otherwise.
Show	Mandatory for consignments based on sorted products that have a commercial format other than "Mixed". N/A otherwise.
Dependence requirements	When a sorted product is defined for a consignment and an address file has been validated and sorted MailingWrapperTypeCode (when applicable) is not allowed to be changed.

Action	Description
Element	PhysicalDataFormatCode
Description	Data format code that represents the physical format of each mail piece within the consignment.
Type and size	n1..2
Formatting	Allowed values are:

Action	Description
	<p>1 (A6 – C6)</p> <p>5 (DIN Long)</p> <p>9 (A5 – C5)</p> <p>13 (Legal)</p> <p>17 (A4 – C4)</p> <p>21 (Other)</p>
Default value	N/A
Applicability	
PreAdviceBulkMailOrder	Mandatory for consignments based on a product that has a commercial format other than “Mixed”. N/A otherwise.
Show	Mandatory for consignments based on a product that has a commercial format other than “Mixed”. N/A otherwise.
TenderBulkMailOrder	Mandatory for consignments based on a product that has a commercial format other than “Mixed”. N/A otherwise.
Show	Mandatory for consignments based on a product that has a commercial format other than “Mixed”. N/A otherwise.
Dependence requirements	<p>When PhysicalDataFormatCode value 21 is specified, the elements PhysicalDataLenght and PhysicalDataWidth are mandatory.</p> <p>When a sorted product is defined for a consignment and an address file has been validated and sorted PhysicalDataFormatCode (when applicable) is not allowed to be changed.</p>

Action	Description
Element	PhysicalDataLength
Description	Length in mm of each mail piece within the consignment.
Type and size	d3.1
Formatting	N/A
Default value	N/A
Applicability	
PreAdviceBulkMailOrder	Mandatory when PhysicalDataFormatCode equals 21 (“Other”). N/A otherwise.
Show	Mandatory when PhysicalDataFormatCode equals 21 (“Other”). N/A otherwise.
TenderBulkMailOrder	Mandatory when PhysicalDataFormatCode equals 21 (“Other”). N/A otherwise.

Action	Description
Show	Mandatory when PhysicalDataFormatCode equals 21 ("Other"). N/A otherwise.
Dependence requirements	See the PostNL website for minimum and maximum allowed values for this element.  When a sorted product is defined for a consignment and an address file has been validated and sorted PhysicalDataLength (when applicable) is not allowed to be changed.

Action	Description
Element	PhysicalDataProductWeight
Description	The weight of a single mail piece in grams.
Type and size	d4.1
Formatting	N/A
Default value	N/A
Applicability	
PreAdviceBulkMailOrder	Mandatory for consignments based on a product that has a commercial format other than "Mixed". Optional for consignments based on a product that has the commercial format "Mixed".
Show	Mandatory for consignments based on a product that has a commercial format other than "Mixed". Optional for consignments based on a product that has the commercial format "Mixed".
TenderBulkMailOrder	Mandatory for consignments based on a product that has a commercial format other than "Mixed". Optional for consignments based on a product that has the commercial format "Mixed".
Show	Mandatory for consignments based on a product that has a commercial format other than "Mixed". Optional for consignments based on a product that has the commercial format "Mixed".

Action	Description
Dependence requirements	<p>For consignments based on a product that has the commercial format “Mixed”, <b>PhysicalDataTotalWeight must be specified to get a calculated PhysicalDataProductWeight.</b>  <b>The calculated value will replace the original when both PhysicalDataProductWeight and PhysicalDataTotalWeight are present.</b>  <b>PhysicalDataProductWeight without PhysicalDataTotalWeight will be removed.</b></p> <p>When a sorted product is defined for a consignment and an address file has been validated and sorted PhysicalDataProductWeight (when applicable) is not allowed to be changed.</p>

Action	Description
Element	PhysicalDataQuantity
Description	The actual number of mail pieces within the consignment.
Type and size	i
Formatting	N/A
Default value	N/A
Applicability	
PreAdviceBulkMailOrder	Mandatory
Show	Mandatory
TenderBulkMailOrder	Mandatory
Show	Mandatory
Dependence requirements	<p>After validating and sorting the address file the PhysicalDataQuantity is calculated based on the addresses in the address file. This calculated quantity can only be adjusted downwards.</p> <p>In all other situations the quantity can be adjusted without limitation.</p>

Action	Description
Element	PhysicalDataThickness
Description	Thickness in mm of each mail piece within the consignment.
Type and size	d2.1
Formatting	N/A
Default value	N/A
Applicability	

Action	Description
PreAdviceBulkMailOrder	<ul style="list-style-type: none"> <li>• Mandatory for consignments based on sorted products that have a commercial format other than “Mixed”.</li> <li>• Optional for consignments based on unsorted products that have a commercial format other than “Mixed”: each supplied PhysicalDataThickness is converted into a class: see PhysicalDataThicknessClass.</li> <li>• N/A otherwise</li> </ul>
Show	Mandatory for consignments based on sorted products that have a commercial format other than “Mixed”. N/A otherwise.
TenderBulkMailOrder	<ul style="list-style-type: none"> <li>• Mandatory for consignments based on sorted products that have a commercial format other than “Mixed”.</li> <li>• Optional for consignments based on unsorted products that have a commercial format other than “Mixed”: each supplied PhysicalDataThickness is converted into a class: see PhysicalDataThicknessClass.</li> <li>• N/A otherwise</li> </ul>
Show	Mandatory for consignments based on sorted products that have a commercial format other than “Mixed”. N/A otherwise.
Dependence requirements	<ul style="list-style-type: none"> <li>• When a sorted product is defined for a consignment and an address file has been validated and sorted PhysicalDataThickness (when applicable) is not allowed to be changed.</li> <li>• In case of an unsorted product with a commercial format other than “Mixed”, it is optional to use either PhysicalDataThickness or PhysicalDataThicknessClass. In case PhysicalDataThickness is used, the value will be converted into a PhysicalDataThicknessClass.</li> </ul>

Action	Description
Element	PhysicalDataThicknessClass
Description	Thicknessclass of each mail piece within the consignment.
Type and size	n1

Action	Description
Formatting	Allowed values are:
	1 (0-5 mm)
	2 (6-10 mm)
	3 (11-15 mm)
	4 (16-32 mm)
	5 (0-32 mm)
Default value	N/A
Applicability	
PreAdviceBulkMailOrder	Optional for consignments based on unsorted products that have a commercial format other than "Mixed". N/A otherwise.
Show	Mandatory for consignments based on unsorted products that have a commercial format other than "Mixed". N/A otherwise.
TenderBulkMailOrder	Optional for consignments based on unsorted products that have a commercial format other than "Mixed". N/A otherwise.
Show	Mandatory for consignments based on unsorted products that have a commercial format other than "Mixed". N/A otherwise.
Dependence requirements	<ul style="list-style-type: none"> <li>• See the PostNL website for allowed values for this element. Values differ per commercial format.</li> <li>• When a sorted product is defined for a consignment and an address file has been validated and sorted PhysicalDataThicknessClass (when applicable) is not allowed to be changed.</li> <li>• In case of an unsorted product with a commercial format other than "Mixed", it is optional to use either PhysicalDataThickness or PhysicalDataThicknessClass. In case PhysicalDataThickness is used, the value will be converted into a PhysicalDataThicknessClass.</li> </ul>

Action	Description
Element	PhysicalDataTotalWeight
Description	The total weight of a consignment in grams.
Type and size	d7.0
Formatting	N/A
Default value	N/A

Action	Description
Applicability	
PreAdviceBulkMailOrder	Optional for consignments based on a product that has commercial format "Mixed". N/A otherwise.
Show	Optional for consignments based on a product that has commercial format "Mixed". N/A otherwise.
TenderBulkMailOrder	Optional for consignments based on a product that has commercial format "Mixed". N/A otherwise.
Show	Optional for consignments based on a product that has commercial format "Mixed". N/A otherwise.
Dependence requirements	<p>For consignments based on a product that has the commercial format "Mixed", either PhysicalDataProductWeight or PhysicalDataTotalWeight must be specified.</p> <p>When a sorted product is defined for a consignment and an address file has been validated and sorted PhysicalDataTotalWeight (when applicable) is not allowed to be changed.</p>

Action	Description
Element	PhysicalDataWidth
Description	Width in mm of each mail piece within the consignment.
Type and size	d3.1
Formatting	N/A
Default value	N/A
Applicability	
PreAdviceBulkMailOrder	Mandatory when PhysicalDataFormatCode equals 21 ("Other"). N/A otherwise.
Show	Mandatory when PhysicalDataFormatCode equals 21 ("Other"). N/A otherwise.
TenderBulkMailOrder	Mandatory when PhysicalDataFormatCode equals 21 ("Other"). N/A otherwise.
Show	Mandatory when PhysicalDataFormatCode equals 21 ("Other"). N/A otherwise.



Action	Description
Dependence requirements	See the PostNL website for minimum and maximum allowed values for this element.  When a sorted product is defined for a consignment and an address file has been validated and sorted PhysicalDataWidth (when applicable) is not allowed to be changed.

### 5.9.5 ConsignmentProcessing

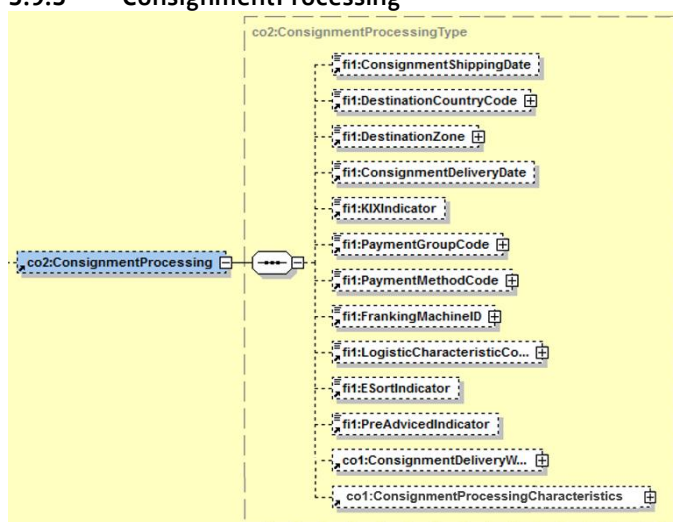

Action	Description
Element	ConsignmentShippingDate
Description	Date on which the consignment is being tendered physically at a PostNL location.
Type and size	datetime
Formatting	N/A
Default value	N/A
Applicability	
PreAdviceBulkMailOrder	Mandatory
Show	Mandatory
TenderBulkMailOrder	Mandatory

Action	Description
Show	Mandatory
Dependence requirements	It is validated that this date: <ul style="list-style-type: none"> <li>• Exists <b>AND</b></li> <li>• Is not in the past <b>AND</b></li> <li>• Is not on a Sunday or public holiday <b>AND</b></li> <li>• Is in line with specific product restrictions</li> </ul>

Action	Description
Element	DestinationCountryCode
Description	The ISO-2 country code for the destination country of the consignment.
Type and size	a2
Formatting	N/A
Default value	N/A
Applicability	
PreAdviceBulkMailOrder	Mandatory when the consignment is based on a foreign product and the destination is a country.
Show	Mandatory when the consignment is based on a foreign product and the destination is a country.
TenderBulkMailOrder	Mandatory when the consignment is based on a foreign product and the destination is a country.
Show	Mandatory when the consignment is based on a foreign product and the destination is a country.
Dependence requirements	It is validated that: <ul style="list-style-type: none"> <li>• The country code exists <b>AND</b></li> <li>• The specified country is a valid destination for the specified product.</li> </ul> When the consignment is based on a foreign product either DestinationCountryCode or DestinationZone are mandatory. When both are specified, only the DestinationCountryCode is used.

Action	Description
Element	DestinationZone
Description	Specified the PostNL zone as the destination zone of the consignment.
Type and size	n..20
Formatting	N/A
Default value	N/A

Action	Description
Applicability	
PreAdviceBulkMailOrder	Mandatory when the consignment is based on a foreign product and the destination is a zone.
Show	Mandatory when the consignment is based on a foreign product and the destination is a zone.
TenderBulkMailOrder	Mandatory when the consignment is based on a foreign product and the destination is a zone.
Show	Mandatory when the consignment is based on a foreign product and the destination is a zone.
Dependence requirements	<p>It is validated that:</p> <ul style="list-style-type: none"> <li>• The zoneID exists <b>AND</b></li> <li>• The specified zoneID is a valid destination for the specified product.</li> </ul> <p>When the consignment is based on a foreign product either DestinationCountryCode or DestinationZone are mandatory. When both are specified, only the DestinationCountryCode is used.</p>

Action	Description
Element	ConsignmentDeliveryDate
Description	Date on which the consignment will be delivered by PostNL.
Type and size	datetime
Formatting	N/A
Default value	N/A
Applicability	
PreAdviceBulkMailOrder	Optional for consignments that are based on products that have a day-based service level. Mandatory for consignments that are based on products that have multiple deliverydates given the shippingdate and service level.
Show	Mandatory for consignments that are based on products that have a day-based service level.
TenderBulkMailOrder	Optional for consignments that are based on products that have a day-based service level. Mandatory for consignments that are based on products that have multiple deliverydates given the shippingdate and service level.
Show	Mandatory for consignments that are based on products that have a day-based service level.

Action	Description
Dependence requirements	The delivery date is checked if it is valid given the shipping date and the specified product if the delivery date is specified. In case not specified then the delivery week is derived given the shipping date and specified product.

Action	Description
Element	KIXIndicator
Description	Indicates whether or not the mail pieces in the consignment are provided with a KIX code.
Type and size	Boolean
Formatting	true or false
Default value	N/A
Applicability	
PreAdviceBulkMailOrder	Optional
Show	Optional
TenderBulkMailOrder	Optional
Show	Optional
Dependence requirements	None

### 5.9.5.1 ConsignmentDeliveryWeek

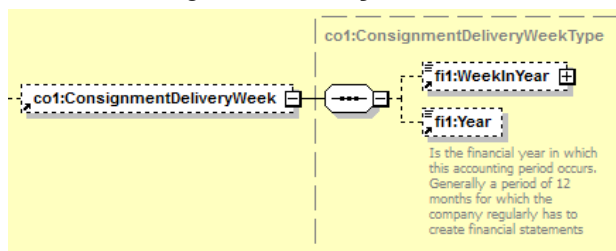

Action	Description
Element	WeekInYear
Description	Calendar week in which the consignment will be delivered by PostNL.
Type and size	n1-2
Formatting	“W” or “WW” and 1 <= WeekInYear <= 53
Default value	N/A
Applicability	
PreAdviceBulkMailOrder	Optional for consignments that are based on products that have a week-based service level.

Action	Description
Show	Mandatory for consignments that are based on products that have a week-based service level.
TenderBulkMailOrder	Optional for consignments that are based on products that have a week-based service level.
Show	Mandatory for consignments that are based on products that have a week-based service level.
Dependence requirements	The delivery week is checked if it is valid given the shipping date and the specified product if the delivery week is specified. In case not specified then the delivery week is derived given the shipping date and specified product.

Action	Description
Element	Year
Description	Year of the calendar week in which the consignment will be delivered by PostNL.
Type and size	n4
Formatting	“YYYY”
Default value	N/A
Applicability	
PreAdviceBulkMailOrder	Optional for consignments that are based on products that have a week-based service level.
Show	Mandatory for consignments that are based on products that have a week-based service level.
TenderBulkMailOrder	Optional for consignments that are based on products that have a week-based service level.
Show	Mandatory for consignments that are based on products that have a week-based service level.
Dependence requirements	The delivery week is checked if it is valid given the shipping date and the specified product if the delivery week is specified. In case not specified then the delivery week is derived given the shipping date and specified product.

### 5.9.5.2 ConsignmentProcessingCharacteristics

Consignment Processing Characteristics become obsolete in new product model.

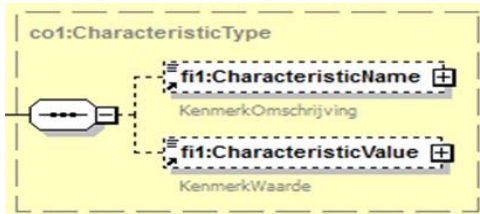

Characteristics defined in this ConsignmentProcessing section of the BulkMailOrder message acts as metadata for additional services that can be added to a consignment. Each characteristic is described by its name and a value. The next table lists all supported characteristics.

Characteristic name	Action	Description
TrackAndCheck	PreAdviceBulkMailOrder TenderBulkMailOrder	Indicates whether or not the additional service Track & Check is applicable to the consignment. This additional service cannot be combined with the TrackAndTrace And MyMail characteristic.
TrackAndTrace	PreAdviceBulkMailOrder TenderBulkMailOrder	Indicates whether or not the additional service Track & Trace is applicable to the consignment. This additional service cannot be combined with the TrackAndCheck And MyMail characteristic.
MyMail	PreAdviceBulkMailOrder TenderBulkMailOrder	Indicates whether or not the additional service MyMail is applicable to the consignment. This additional service cannot be combined with the TrackAndCheck and the TrackAndTrace characteristic.
Coding line	PreAdviceBulkMailOrder TenderBulkMailOrder	Indicates whether or not the additional service Codingline (+2D matrix) is applicable to the consignment. This additional service cannot be combined with Sorted
INF002.016 Mail pieces digital returned when not deliverable.	PreAdviceBulkMailOrder TenderBulkMailOrder	Indicates whether or not the additional service INF002.016 is applicable to the consignment.
INF002.017 Mail pieces digital and physical returned when not deliverable.	PreAdviceBulkMailOrder TenderBulkMailOrder	Indicates whether or not the additional service INF002.017 is applicable to the consignment.

Characteristic name	Action	Description
INF002.018 Mail pieces physical returned when not deliverable. Default.	PreAdviceBulkMailOrder TenderBulkMailOrder	Indicates whether or not the additional service INF002.017 is applicable to the consignment.

When a characteristic is used, both name and value must be present. The characteristic name must be supplied as described in the table above. Characteristic values can have different restrictions. All supported characteristic values are described in the next set of tables.

Action	Description (CharacteristicValue)
Element	TrackAndCheck
Description	Indicator whether or not the additional service Track & Check is applicable for this consignment.
Type and size	boolean
Formatting	true or false
Default value	false (characteristic not present)
Applicability	
PreAdviceBulkMailOrder	Optional
Show	Mandatory when specified in PreAdviceBulkMailOrder. N/A otherwise.
TenderBulkMailOrder	Optional
Show	Mandatory when specified in PreAdviceBulkMailOrder. N/A otherwise.
Dependence requirements	The following restrictions apply for the TrackAndCheck characteristic: <ul style="list-style-type: none"> <li>• Cannot be combined with TrackAndTrace and MyMail characteristic on the same consignment.</li> <li>• Cannot be used when tendering a consignment if this characteristic was not present when pre-advising the consignment.</li> </ul>

Action	Description (CharacteristicValue)
Element	TrackAndTrace
Description	Indicator whether or not the additional service Track & Trace is applicable for this consignment.
Type and size	boolean
Formatting	true or false

Action	Description (CharacteristicValue)
Default value	false (characteristic not present)
Applicability	
PreAdviceBulkMailOrder	Optional
Show	Mandatory when specified in PreAdviceBulkMailOrder. N/A otherwise.
TenderBulkMailOrder	Optional
Show	Mandatory when specified in PreAdviceBulkMailOrder. N/A otherwise.
Dependence requirements	The following restrictions apply for the TrackAndCheck characteristic: <ul style="list-style-type: none"> <li>• Cannot be combined with TrackAndTrace and MyMail characteristic on the same consignment.</li> <li>• Cannot be used when tendering a consignment if this characteristic was not present when pre-advising the consignment.</li> </ul>

Action	Description (CharacteristicValue)
Element	MyMail
Description	Indicator whether or not the additional service MyMail is applicable for this consignment.
Type and size	boolean
Formatting	true or false
Default value	false (characteristic not present)
Applicability	
PreAdviceBulkMailOrder	Optional
Show	Mandatory when specified in PreAdviceBulkMailOrder. N/A otherwise.
TenderBulkMailOrder	Optional
Show	Mandatory when specified in PreAdviceBulkMailOrder. N/A otherwise.
Dependence requirements	The following restrictions apply for the MyMail characteristic: <ul style="list-style-type: none"> <li>• Cannot be combined with TrackAndTrace and MyMail characteristic on the same consignment.</li> <li>• Cannot be used when tendering a consignment if this characteristic was not present when pre-advising the consignment.</li> </ul>



### 5.9.5.3 ConsignmentDeliveryTimePeriod

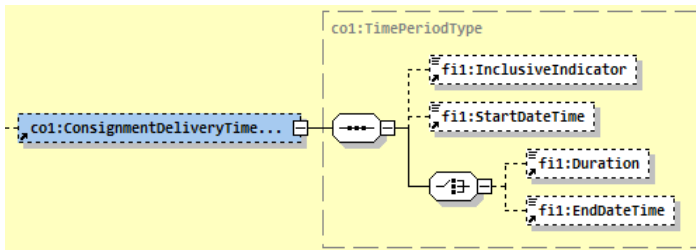

Action	Description
Element	StartDateTime
Description	Start timestamp indicating the starting point of the event.
Type and size	date
Formatting	YYYY-MM-DD
Default value	N/A
Applicability	
PreAdviceBulkMailOrder	Optional for consignments that are based on products that have a week-based or a 48-72h service level.
Show	Mandatory for consignments that are based on products that have a week-based or a 48-72h service level.
TenderBulkMailOrder	Optional for consignments that are based on products that have a week-based or a 48-72h service level.
Show	Mandatory for consignments that are based on products that have a week-based or a 48-72h service level.
Dependence requirements	The delivery period is checked if it is valid given the shipping date and the specified product if the delivery date is specified. In case not specified then the delivery date is derived given the shipping date and specified product.

Action	Description
Element	EndTime
Description	End timestamp indicating the end point of the event.
Type and size	date
Formatting	YYYY-MM-DD
Default value	N/A
Applicability	
PreAdviceBulkMailOrder	Optional for consignments that are based on products that have a week-based or a 48-72h service level.
Show	Mandatory for consignments that are based on products that have a week-based or a 48-72h service level.

Action	Description
TenderBulkMailOrder	Optional for consignments that are based on products that have a week-based or a 48-72h service level.
Show	Mandatory for consignments that are based on products that have a week-based or a 48-72h service level.
Dependence requirements	The delivery period is checked if it is valid given the shipping date and the specified product if the delivery date is specified. In case not specified then the delivery date is derived given the shipping date and specified product.

### 5.9.6 CustomerConsignment

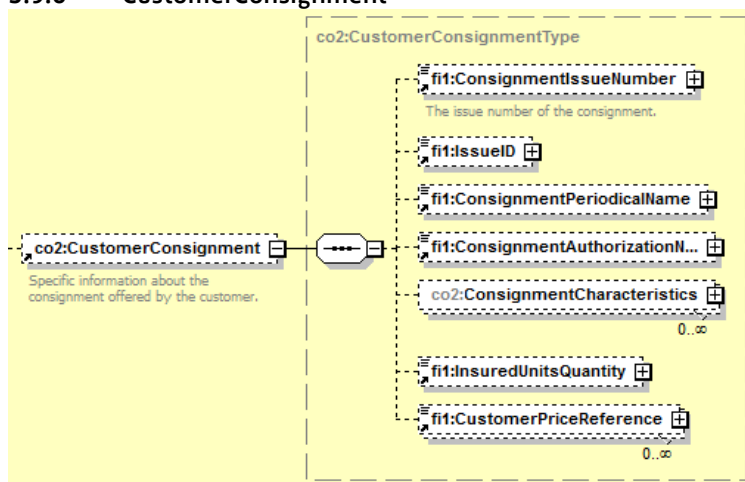

Action	Description
Element	ConsignmentIssueNumber
Description	Issue number of the periodical this consignment is based on.
Type and size	n..3
Formatting	N/A
Default value	N/A
Applicability	
PreAdviceBulkMailOrder	Mandatory when the consignment is based on a periodical product. N/A otherwise.
Show	Mandatory when the consignment is based on a periodical product. N/A otherwise.
TenderBulkMailOrder	Mandatory when the consignment is based on a periodical product. N/A otherwise.

Action	Description
Show	Mandatory when the consignment is based on a periodical product. N/A otherwise.
Dependence requirements	

Action	Description
Element	IssueID
Description	Unique identification of the issue to which this consignment relates.
Type and size	n12
Formatting	N/A
Default value	N/A
Applicability	
PreAdviceBulkMailOrder	N/A
Show	Mandatory
TenderBulkMailOrder	N/A
Show	Mandatory
Dependence requirements	<p>When a consignment is updated, the IssueID is never modified. The relation between IssueID and ConsignmentID is never broken.</p> <p>When tendering consignments, ConsignmentID is mandatory and IssueID is not applicable. When all consignments within the same issue must be tendered, these consignments must all be tendered separately (within a single or multiple invocations).</p>

Action	Description
Element	ConsignmentPeriodicalName
Description	Name of the Periodical this consignment is based on.
Type and size	a..30
Formatting	N/A
Default value	N/A
Applicability	
PreAdviceBulkMailOrder	When product is a periodical product: Optional for old type contracts. For new type of contracts N/A.
Show	When product is a periodical product: Mandatory for old and new type of contracts.
TenderBulkMailOrder	When product is a periodical product: Optional for old type contracts. For new type of contracts N/A.
Show	When product is a periodical product:

Action	Description
	Mandatory for old and new type of contracts.
Dependence requirements	In case of new contracts, the PeriodicalName is returned in the response when a ConsignmentAuthorisation number and a Contract description is send.

Action	Description
Element	ConsignmentAuthorizationNumber
Description	Authorization number for the Periodical this consignment is based on.
Type and size	n..10
Formatting	N/A
Default value	N/A
Applicability	
PreAdviceBulkMailOrder	When product is a periodical product: Mandatory for new type of contract. N/A for old type of contract.
Show	When product is a periodical product: Mandatory for new type of contract. N/A for old type of contract.
TenderBulkMailOrder	When product is a periodical product: Mandatory for new type of contract. N/A for old type of contract.
Show	When product is a periodical product: Mandatory for new type of contract. N/A for old type of contract.
Dependence requirements	For new type of contract this element is coherent with ContractDescription. Then a periodicalName is returned.

### 5.9.7 ItemID

ItemID (5.9.1) is used for current (unique) product codes / numbers.

CommercialProduct is the new product structure (1voud).

New product don't have old (unique) product codes / numbers

Old products also have a definition in the new product structure (1voud)as well.

We aim one way of working in a phase some customer use current products and other customers use new product.

Therefore we will provide for current products the product code (column 4 as we do now) and also the new product structure (columns 6-9)

New products are defined in columns 6-9 and as said before they don't hav a value in column 4.

Technically, use always columns 4 and 6-9.

## Technische uitleg: van Contractrapportage naar MIG

1	2	3	4	5	6	7	8	9	10	11	12	13
Email	Account_Customer_Number	Account_Name	ProductCode	ProductName	CommercialProduct	ProductCode	ServiceLevel	ProductSoort	AdresbestaanService_Lev	ContractID	Contract_omsd	
				48-72uur DM Klein	20420	7301	48-72UUR	DFLT				
				Maatwerk DM Klein, Flex	20420	7301	NEXTWK/FLEX	DFLT				
				48-72uur DM Groot	20420	7302	48-72UUR	DFLT				



24	25	26	27	28	29	30	31	32	33	34	35
KIX	Coded	Sorted	TrackAndTrace	TrackAndCheck	Mymail	Mixed Separated	reserve	reserve	reserve	reserve	reserve
	VPK006.009		INF001.005	INF001.007	INF002.014						
	VPK006.009		INF001.005	INF001.007	INF002.014						
	VPK006.009	DEP006.001	INF001.005	INF001.007	INF002.014						

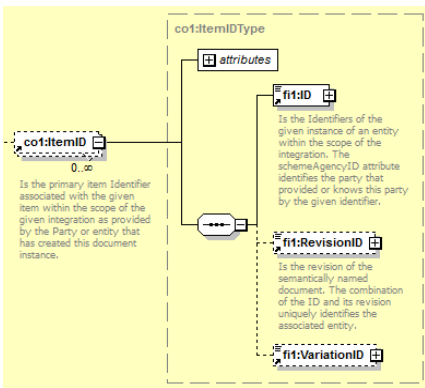

Action	Description
Element	ID
Description	Product code of the consignment.
Type and size	n4
Formatting	N/A
Default value	N/A
Applicability	
PreAdviceBulkMailOrder	Optional 1. Mandatory when a product code is used as product definition.

Action	Description
	2. Forbidden as CommercialProduct (5.9.3) is used
Show	Optional 3. Mandatory when a product code is used as product definition. 4. Forbidden as CommercialProduct (5.9.3) is used
TenderBulkMailOrder	Optional 5. Mandatory when a product code is used as product definition. 6. Forbidden as CommercialProduct (5.9.3) is used
Show	Optional 7. Mandatory when a product code is used as product definition. 8. Forbidden as CommercialProduct (5.9.3) is used
Dependence requirements	The product code is validated. When a product requires specific additional consignment fields it is also verified that these fields are present and valid in the consignment.  When a sorted product is defined for a consignment and an address file has been validated and sorted, the productcode can only be changed to another sorted product. It is not allowed to change to an unsorted product.

### 5.9.9 PictureAttachment

Action	Description
Element	EmbeddedData
Description	Mymail picture
Type and size	an
Formatting	base64 encoded file
Default value	N/A
Applicability	
PreAdviceBulkMailOrder	optional
Show	
TenderBulkMailOrder	optional
Show	
Dependence requirements	New products: Use of Mymail INF002.014 as CommercialServiceID as part of the CommercialProduct. Old Product Use of Mymail in Consignment Processing Characteristics

### 5.9.10 ReturnTo Party

#### 5.9.10.1 Location

##### 5.9.2.1.1 Address

###### StreetName

Action	Description
Definition of element	Name of the street in which the delivery point is situated
Description	
Size	A32
Formatting	Text
Multiplicity	0..1
Fixed value	N/A
Dependence requirements	N/A
Applicability	Optional

###### BuildingNumber

Action	Description
Definition of element	Building number, postoffice box number or businessreply number
Description	
Size	N5
Formatting	Numeric
Multiplicity	0..1
Fixed value	N/A
Dependence requirements	N/A
Applicability	Optional

#### **BuildingNumberExtension**

Action	Description
Definition of element	Building number extension of the delivery point
Description	
Size	A6
Formatting	Text
Multiplicity	0..1
Fixed value	N/A
Dependence requirements	N/A
Applicability	Optional

#### **PostalCode**

Action	Description
Definition of element	Postal code of the delivery point
Description	
Size	A6
Formatting	Text
Multiplicity	0..1
Fixed value	N/A
Dependence requirements	N/A
Applicability	Optional

#### **CityName**

Action	Description
Definition of element	Name of the city in which the delivery point is situated
Description	
Size	A32
Formatting	Text
Multiplicity	0..1



Fixed value	N/A
Dependence requirements	N/A
Applicability	Optional

### 5.9.11 Status

Action	Description
Element	Status
Description	<p>Status field for canceling of a consignment.  Consignments with status pre advised can be removed.  Consignments with status tendered can be removed until the shipping date.</p> <p>Related EROR E2105  The consignment '{0}' can no longer be removed. Consignments with status pre advised can be removed. Consignments with status tendered can be removed until the shipping date.</p>
Type and size	an
Formatting	Use value Cancelled
Default value	
Applicability	
PreAdviceBulkMailOrder	optional
Show	
TenderBulkMailOrder	
Show	
Dependence requirements	

```
</hum:ConsignmentCharacteristics>
</hum:CustomerConsignment>
<hum:ItemID>
  <hum:ItemIDType>
    <hum:ID>
      <hum:Value/>
    </hum:ID>
  </hum:ItemIDType>
</hum:ItemID>

  <hum:Status>
    <hum:Value>Cancelled</hum:Value>
  </hum:Status>

</hum:ConsignmentType>
</hum:Consignment>
<hum:CustomerParty>
  <hum:PartyIDs>
    <hum:ID>
```

## 6 Error handling

*Remark: The list of error codes may not be complete yet and might be extended in the future.*

There are 2 components reserved for holding status and error codes and descriptions as described in sections 4.3.1 and 5.4. The header part of the message (section 4.3.1) contains the result of an invocation. In case of an error, both message structure errors and validation/functional errors are reported.

The Status part of the message is currently not used.

Section 6.1 lists the supported errors in message structure and section 6.2 lists the supported validation and functional errors.

When a BulkMailOrder message was processed correctly, the specific success code and status code “0” with message “Success” are returned.

When an error is encountered, a specific error code and error message are returned.

### 6.1 Success

Error code 0 and message “Success” is returned.

Code	Message
0	Success

### 6.2 Message structure error codes and messages

The range “E0001 – E0999” is reserved for message structure errors.

Code	Message
E0001	The element '{0}' cannot be null
E0002	The parameter '{0}' cannot be null
E0003	The parameter '{0}' does not contain elements
E0004	The value of parameter '{0}' cannot be null
E0005	Exactly one '{0}' should be specified
E0006	Calling party is not authorized to use B2B-service.
E0007	The user is not authorized or does not exist. Verify the provided Id in '{0}'. Please contact account support.
E0008	A unknown error has occurred
E0009	A backend system was not available to process your request. Please try again. Keep an eye on the website of MijnPost in case it is a general failure of the PostNL systems.
E0010	User validation failed. Please try again.

Code	Message
E0011	Consignment retrieving failed. Please try again.
E0012	An unknown validation error occurred

### 6.3 Validation and functional error codes and messages

The range “E2000 – E2999” is reserved for validation and functional errors.

Code	Message
E2000	Parameter '{0}' should be equal to null
E2001	A maximum of {0} elements in property '{1}' are allowed
E2002	Parameter '{0}' unequal to your customernumber.
E2003	The provided value in parameter '{0}' does not exist.
E2004	The provided '{0}' is not active.
E2005	It is not possible to offer mail on account with the provided customernumber.
E2006	Not all provided consignments have the same offer date
E2007	Consignment not found because '{0}' differs from '{1}'
E2008	Consignment is already offered.
E2009	Parameter '{0}' should be equal to null while offering.
E2010	Parameter '{0}' should be provided when the product is closed.
E2011	Because contracttype equals {0} the contractId is invalid
E2012	Invalid combination of '{0}' and '{1}'.
E2013	The provided value in parameter '{0}' does not exist in combination with the provided values in '{1}' and '{2}'
E2014	The combination of the value in parameter '{0}' and '{1}' is invalid
E2015	Parameter '{0}' should not contain more than {1} characters
E2016	'{0}' has an invalid value. Therefore, the value cannot be parsed.
E2017	The provided value in parameter '{0}' should be between {1} and {2}.
E2018	The combination of the provided values in parameters '{0}' and '{1}' is invalid. Please verify that this product can be offered at the provided '{2}'
E2019	The value of parameter '{0}' should not be less than the minimum of {1}
E2020	The value of parameter '{0}' should not be greater than the maximum of {1}
E2021	The provided date in parameter '{0}' is in the past
E2022	The provided date in parameter '{0}' has a wrong day specified. Day '{1}' is not valid for the given product and contract.
E2023	The provided date in parameter '{0}' is a public holiday or a weekend day. Therefore the provided date is invalid.
E2024	Because the product has servicewindow '{0}' only {1} are valid shippingdays. Therefore the provided value in parameter '{2}' is invalid.
E2025	The provided value in parameter '{0}' is not allowed.

<b>Code</b>	<b>Message</b>
E2026	'{0}' is different from the result of multiplying '{1}' and '{2}'. Therefore the provided value in '{0}' or '{1}' is invalid.
E2027	The provided value for the property '{0}' is not supported.
E2028	Consignment '{0}' can't be tendered. The consignment is not yet pre-advised or – in case of a sorted product – the address file has not yet been sorted. This is required for the Tender method.
E2029	Consignment '{0}' has already been tendered.
E2030	Consignment '{0}' has a linear or mixed product so it shouldn't contain dimensions, thickness and packaging.
E2031	Quantity '{0}' of consignment '{1}' can only be adjusted downwards. The current quantity of the consignment is '{2}'
E2032	Consignment '{0}' can't be validated or sorted. Validate and sort is not allowed after a manual split of the consignment.
E2033	The provided Contract value '{0}' and ContractPosition value '{1}' cannot be matched with current contract(s) from customernumber '{2}' and the provided consignment data.
E2034	The provided productcode '{0}' in consignment '{1}' is not allowed to be changed from productcode '{2}'. You cannot change a sorted product to an unsorted product or the other way around.
E2035	The parameter '{0}' cannot be changed for consignment '{1}', because the consignment has been sorted.
E2036	Consignment '{0}' can't be tendered. The address file has to be validated for the provided product. This is required for the Tender method.
E2037	Parameter '{0}' is mandatory for the provided product.
E2038	Parameter '{0}' should be provided for the product instead of parameter '{1}'.
E2039	The combination of shipping date '{0}', servicewindow '{1}' and delivery date (or delivery week) '{2}' is not valid for the provided product.
E2040	Date '{0}' is not valid for the provided product and contract.
E2041	The parameter '{0}' cannot be changed for consignment '{1}', because the consignment has Track & Check or Track & Trace and the address file is already validated.
E2042	The consignment '{0}' cannot be updated.
E2043	One or more product configurations did not match a contract number and description combination.
E2100	Value is missing while an Orik is being used.
E2101	The consignmentCharacteristic with allways orik 1 with its value is required.
E2102	Value of consignmentID in the TenderBulkMailOrder request is not recognized. ConsignmentID should be numeric12 and without blank spaces (123456789000).

<b>Code</b>	<b>Message</b>
E2103	Retour keuze is op dit moment nog een pilot en daarom niet beschikbaar voor elk klantnummer. Voor aanvullende vragen kunt u contact opnemen met uw account manager.
E2104	The provided picture attachment is invalid.
E2105	The consignment '{0}' can no longer be removed. Consignments with status pre advised can be removed. Consignments with status tendered can be removed until the shipping date.

### 6.3.1 Validation error codes

Remark: The list of error codes may not be complete yet and might be extended in the future.

Code	Message
VAL1.1	Klant ontbreekt in het input bericht.
VAL1.2	Klant {0} bestaat niet.
VAL1.3	Klant {0} is niet actief.
VAL1.4	Klant type {0} is ongeldig.
VAL1.5	Klant {0} heeft een aanbiedblokkade.
VAL1.6	Klant {0} is niet geverifieerd.
VAL3.1	Partij met ID {0} - Er is een niet bestaande aanbiedlocatie {0} opgegeven.
VAL3.2	Partij met ID {0} heeft een ongeldige aanbiedlocatie {0}.
VAL4.1	Product {0} bestaat niet
VAL4.2	Product {0} is niet actief.
VAL6.1	Partij met ID {0} - Voor dit product is een contract verplicht.
VAL6.6	Partij met ID {0} - Voor deze partij is geen geldig contract gevonden.
VAL6.10	Partij met ID {0} - Er is geen geldig contract gevonden door een ongeldige: {1}, {2}, {3}, {4}, {5}
VAL7.1	Partij met ID {0} - Het jaar en/of weeknummer van bezorging ontbreekt.
VAL7.2	Partij met ID {0} - Datum van bezorging ontbreekt.
VAL7.4	Partij met ID {0} - De bezorgdatum mag niet voor de aanbieddatum liggen.
VAL7.5	Partij met ID {0} - De bezorgdatum ligt in het verleden.
VAL7.10	Partij met ID {0} - Bezorgmoment komt niet overeen met aanbieddatum.
VAL7.11	Partij met ID {0} - Bezorgmoment mag niet op een zondag, maandag of feestdag
VAL7.13	Partij met ID {0} - Bezorgmoment ligt te ver in de toekomst.
VAL7.14	Partij met ID {0} - Bezorgmoment komt niet overeen met aanmaakdatum.
VAL7.15	Partij met ID {0} - Bezorgmoment en bezorgdatum komen niet overeen.
VAL7.17	Partij met ID {0} - Bezorgmoment en bezorgweek komen niet overeen.
VAL9.1	Partij met ID {0} - ORIK1Waarde ontbreekt of is leeg.
VAL9.2	Partij met ID {0} - ORIK1Waarde is te lang(maximaal 30 tekens).
VAL9.3	Partij met ID {0} - ORIK1Omschrijving ontbreekt of is leeg.
VAL9.4	Partij met ID {0} - ORIK1Omschrijving is te lang(maximaal 30 tekens).
VAL10.3	Partij met ID {0} heeft ontbrekende aanbieddatum.
VAL10.4	Partij met ID {0} - De aanbieddatum ligt in het verleden.
VAL10.5	Partij met ID {0} mag niet op zaterdag, zondag of een feestdag aangeboden worden.
VAL10.14	Partij met ID {0} - De aanbieddatum ligt te ver in de toekomst
VAL10.15	Partij met ID {0} - De aanbieddatum mag alleen op een {1}
VAL10.16	Partij met ID {0} - De aanbieddatum komt niet overeen met bezorgdatum.
VAL11.1	Partij met ID {0} heeft een ongeldige landcode.

VAL12.1	Partij met ID {0} heeft een ongeldige zonecode {1}.
VAL13.1	Partij met ID {0} - Vul de zone of de landcode in.
VAL16.1	Partij met ID {0} - Editienummer ontbreekt.
VAL16.2	Partij met ID {0} - Editienummer mag alleen worden meegegeven bij periodieke producten.
VAL17.1	Partij met ID {0} heeft een ongeldige dikte of dikteklasse.
VAL17.2	Partij met ID {0} heeft een ongeldige FormaatKlasse.
VAL17.3	Partij met ID {0} heeft een ongeldige VerpakkingsCode.
VAL17.4	Partij {0} - Formaatcode is verplicht voor gesorteerde producten.
VAL17.5	Partij {0} - Verpakkingscode is verplicht voor gesorteerde producten.
VAL17.6	Partij {0} - Dikte is verplicht voor gesorteerde producten.
VAL17.7	Partij {0} - Dikteklasse is verplicht voor ongesorteerde producten vanaf 5000 stuks.
VAL17.8	Partij met ID {0} - Formaatklasse is verplicht voor ongesorteerde producten vanaf 5000 stuks.
VAL17.9	Partij met ID {0} - Verpakkingscode is verplicht voor ongesorteerde producten vanaf 5000 stuks.
VAL18.1	Partij met ID {0} - Lengte en breedte zijn verplicht bij afmeting overig. Partij met ID {0} - De opgegeven waarde lengte zou tussen de {minLength} en {maxLength} moeten zijn. Partij met ID {0} - De opgegeven waarde breedte zou tussen de {minWidth} en {maxWidth} moeten zijn. Partij met ID {0} Lengte en breedte kunnen niet gecontroleerd worden.
VAL19.1	Partij met ID {0} heeft een ongeldig totaalgewicht.
VAL19.2	Partij met ID {0} - Er is geen gewicht opgegeven. Partij met ID {0} - Gewicht zou niet groter moeten zijn dan het maximum van {MaximumGewicht}. Partij met ID {0} - Gewicht zou niet kleiner moeten zijn dan het minimum van {MinimumGewicht}.
VAL19.3	Partij met ID {0} Uw partij Gemengd overschrijdt het maximum gewicht van {1}g. U wordt geadviseerd uw partij aan te bieden als Gemengd Extra.
VAL20.1	Partij met ID {0} is ongeldig. Er is geen aantal ingevuld.
VAL20.2	Partij met ID {0} is ongeldig. Het aantal moet geldig zijn(1-9999999).
VAL23.1	Partij met ID {0} is ongeldig. Voor gemengde partijen moet Lengte leeg zijn
VAL23.2	Partij met ID {0} is ongeldig. Voor gemengde partijen moet Breedte leeg zijn
VAL23.3	Partij met ID {0} is ongeldig. Voor gemengde partijen moet Dikte leeg zijn
VAL23.4	Partij met ID {0} is ongeldig. Voor gemengde partijen moet DikteKlasse leeg zijn
VAL23.5	Partij met ID {0} is ongeldig. Voor gemengde partijen moet FormaatKlasse leeg zijn
VAL23.6	Partij met ID {0} is ongeldig. Voor gemengde partijen moet VerpakkingsCode leeg zijn
VAL27.1	Partij met ID {0} heeft een ongeldige waarde in CommercialOption.



VAL28.2	Partij met ID {0} - Met dit product mag u de partij niet voormelden, gebruik alternatief product {0}.
VAL31.1	Partij met ID {0} - AdresseringsLabelingType is verplicht voor verpakkingscode (5) folie
VAL31.2	Partij met ID {0} - AdresseringsLabelingType is ongeldig
VAL32.1	Partij met ID {0} - Geen geldige periodieke titels gevonden voor de combinatie van contractomschrijving: {1} en consignment authorization number: {2}.
VAL32.2	Partij met ID {0} - Meerdere periodieke titels gevonden voor de combinatie van contractomschrijving: {1} en consignment authorization numbers: {2} . De volgende consignment authorization number zijn beschikbaar: {3}.
VAL33.1	Partij met ID {0} is ongeldig - Er is geen CommercialServiceId ingevuld bij 1 of meerdere CommercialServices.
VAL33.2	Partij met ID {0} - De waarde in commercialServiceId {0} hoort niet bij het gebruikte product.",
VAL33.3	Partij met ID {0} is ongeldig - Services VPK006.009 (Codeerregel + 2D matrix) en DEP006.001 (Gesorteerd) mogen niet worden gecombineerd.
VAL33.4	Partij met ID {0} is ongeldig - Je mag slechts 1 van services INF001.005 (Track&Trace), INF001.007 (Track&Check) of INF002.014 (MyMail) kiezen.
VAL33.5	Partij met ID {0} is ongeldig - Service VPK006.009 (Codeerregel + 2D matrix) is verplicht als INF001.007 (Track&Check) is gekozen.
VAL33.6	Partij met ID {0} is ongeldig - Service DEP006.001 (Gesorteerd) of VPK006.009 (Codeerregel + 2D matrix) is verplicht als service INF002.014 (MyMail) of ServiceLevel (NEXTWKFLEX of NEXTWK) is gekozen.
VAL33.8	Partij met ID {0} is ongeldig - Je mag slechts 1 van de services INF002.015 (Geen retour), INF002.016 (Digitaal retour), INF002.017 (Digitaal en fysiek retour) of INF002.0018 (Fysiek retour) kiezen.
VAL33.9	Partij met ID {0} is ongeldig - Service DEP006.001 (Gesorteerd) of VPK006.009 (Codeerregel + 2D matrix) is verplicht als service INF002.015 (Geen retour), INF002.016 (Digitaal retour), INF002.017 (Digitaal en fysiek retour) of INF002.0018 (Fysiek retour) is gekozen.
VAL33.10	Vanaf 25.000 stuks van formaat GROOT (productcode 7302) moet afhankelijk van de afwerking gesorteerd worden (DEP006.001). Te sorteren afwerkingen: geen verpakking(8), folie(5), banderol(23) of met gadget(99).
VAL33.11	Gemengd Gesplitst (gesplitst op formaten klein, groot speciaal) is alleen van toepassing vanaf (>=) 2500 stuks.
VAL33.12	Bij een retour adres hoort een retour keuze (digitaal INF002.016, fysiek INF002.018 of beide INF002.017).
VAL33.13	Bij service INF002.018 (poststukken retour) hoort een retouradres.
VAL33.14	Bij service INF002.017 (digitaal retour en poststukken retour) hoort een een retouradres.

VAL33.15	Bij service INF002.018 (poststukken retour) hoort een retouradres.
VAL33.16	Bij service INF002.017 (digitaal retour en poststukken retour) hoort retouradres.